



The Galactic Context of the Radius Valley

Angharad Weeks

Vincent Van Eylen, Daisuke Kawata, Dan Huber, Amalie Stokholm, Jakob Lysgaard Rørsted, Mark Winther, Travis Berger, Tim Bedding, Martin Nielsen, Yaguang Li

Mullard Space Science Laboratory, UCL
Sydney Institute for Astronomy, USyd

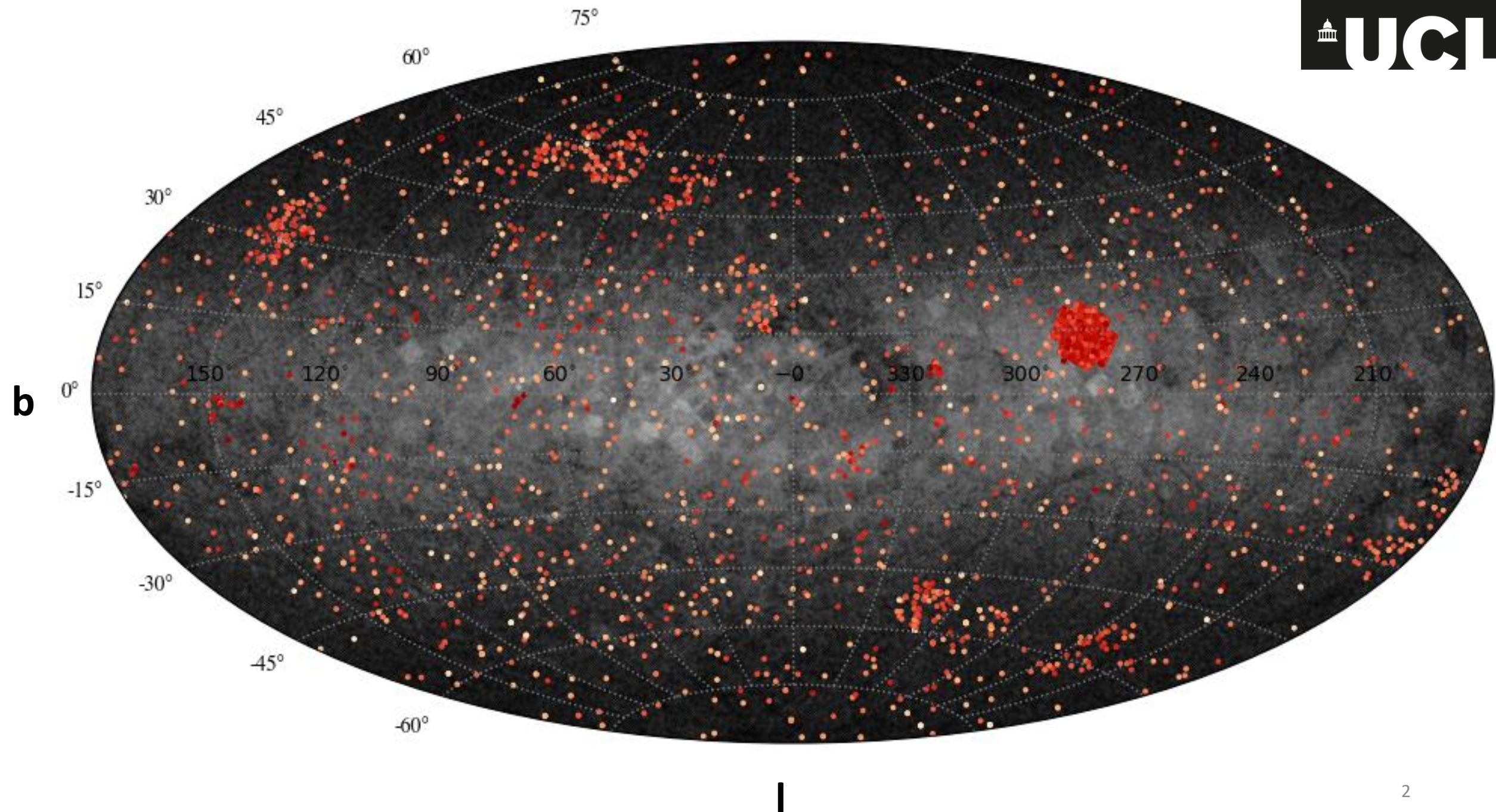

The Radius Valley

 *Sub-Neptunes*

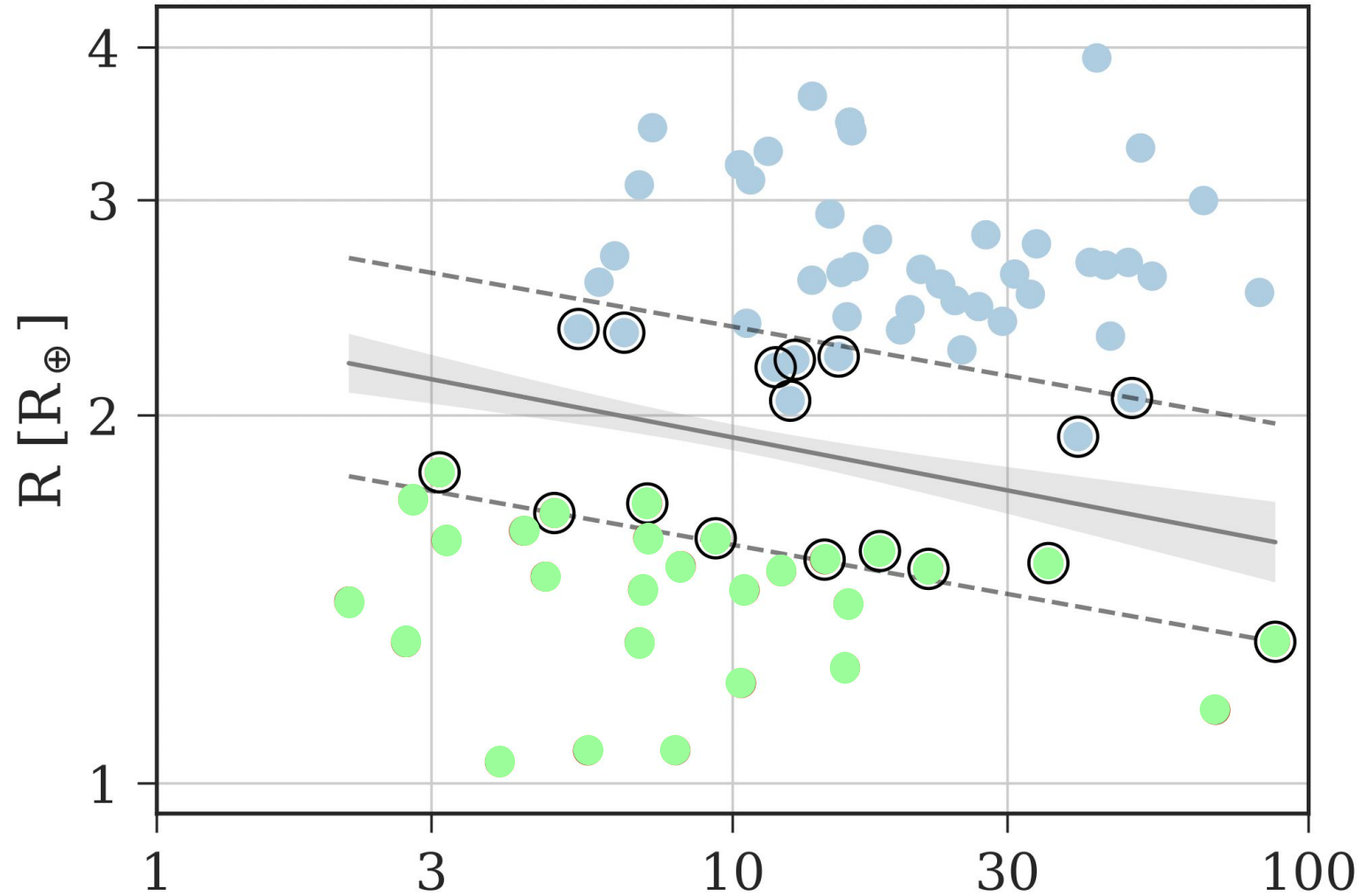

 *Super-Earths*

The Radius Valley

 *Sub-Neptunes*

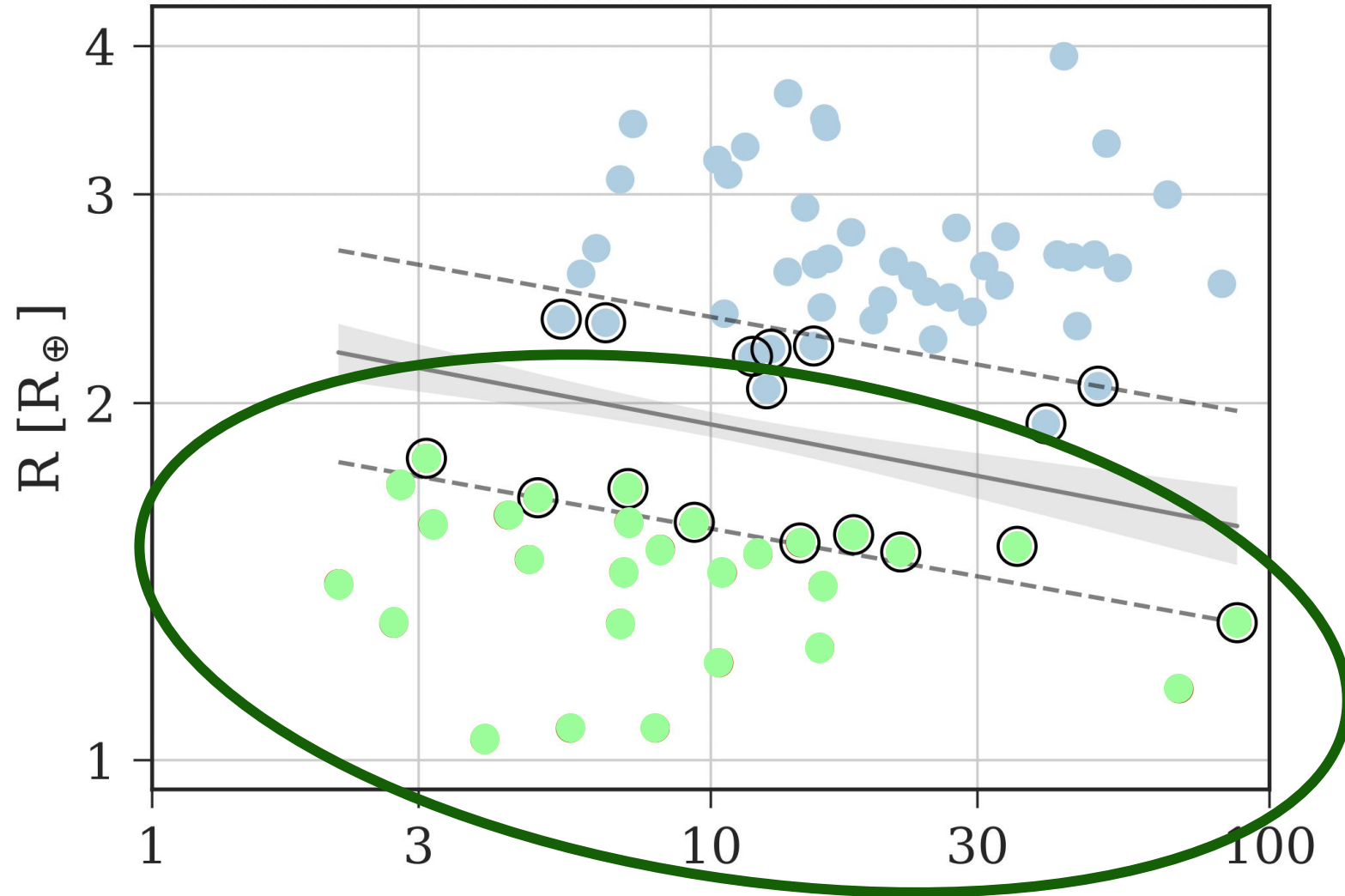

 *Super-Earths*

Rocky planets?

Does this link
to these
elements in
the Galaxy?

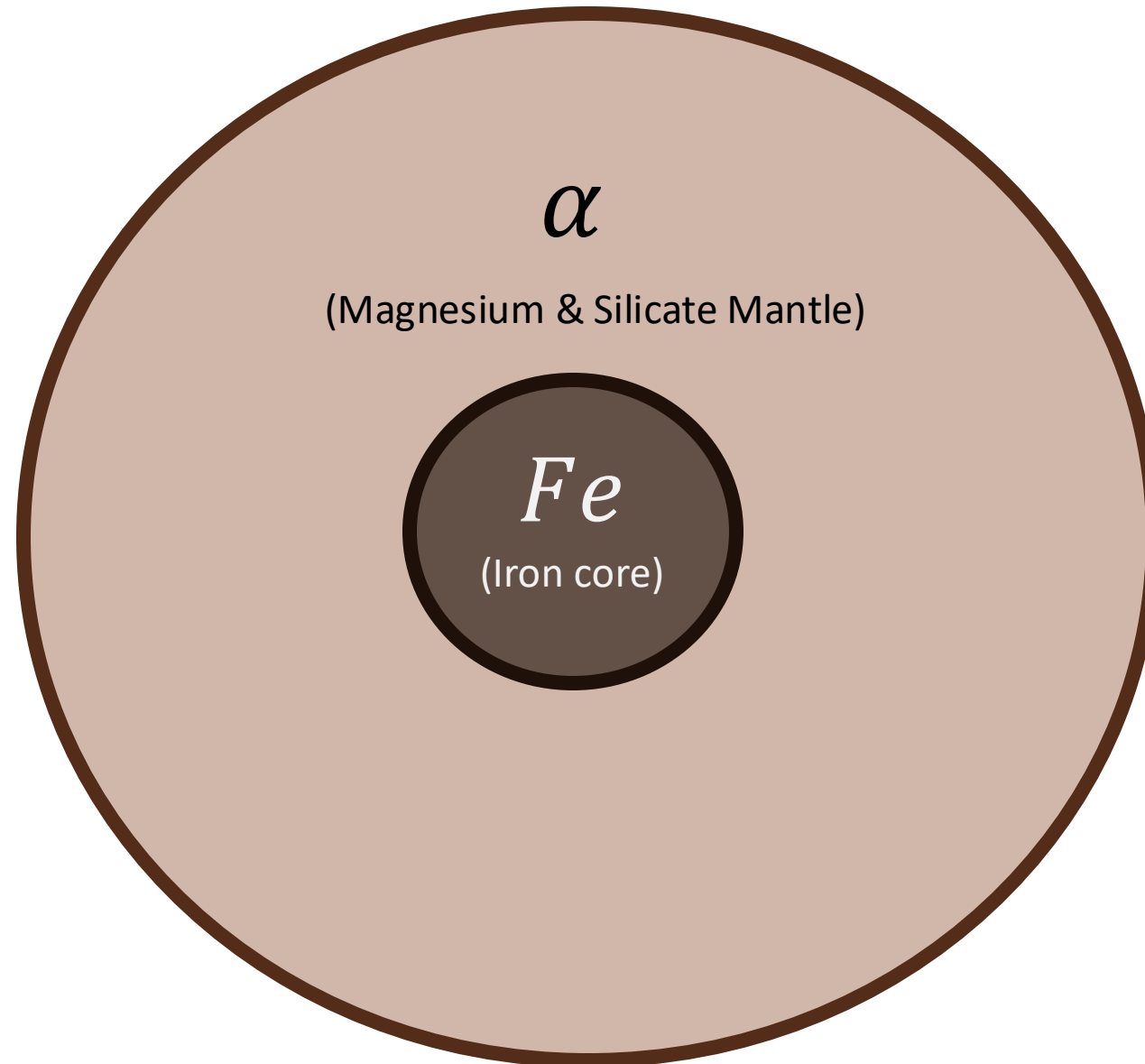

Galactic Chemical Evolution

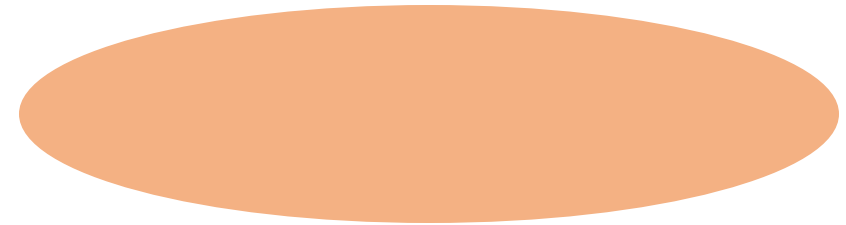
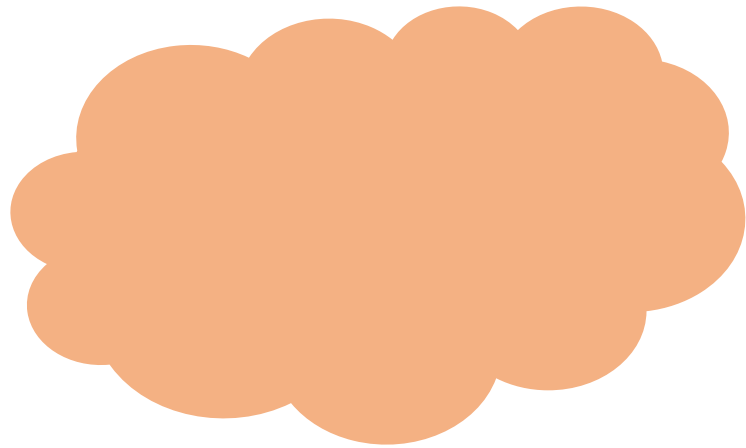

0

14

Time [Gyr]

Galactic Chemical Evolution

Nucleosynthesis:

- Type II supernovae
- Type Ia supernovae
- Stellar Feedback

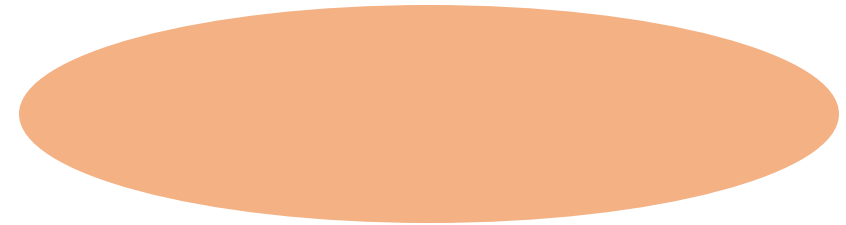
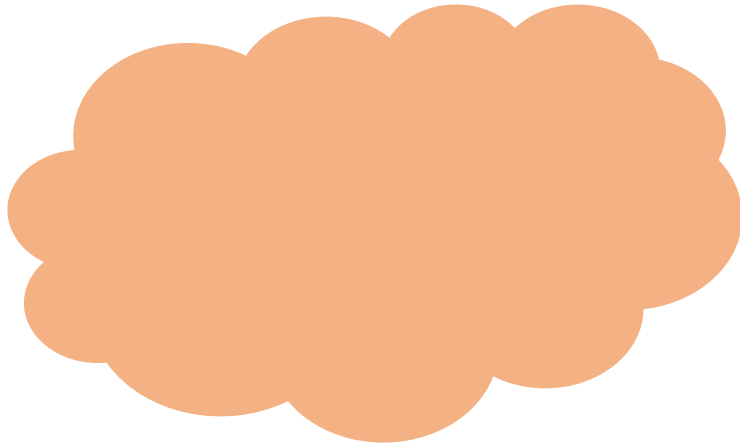

0

14

Time [Gyr]

Galactic Chemical Evolution

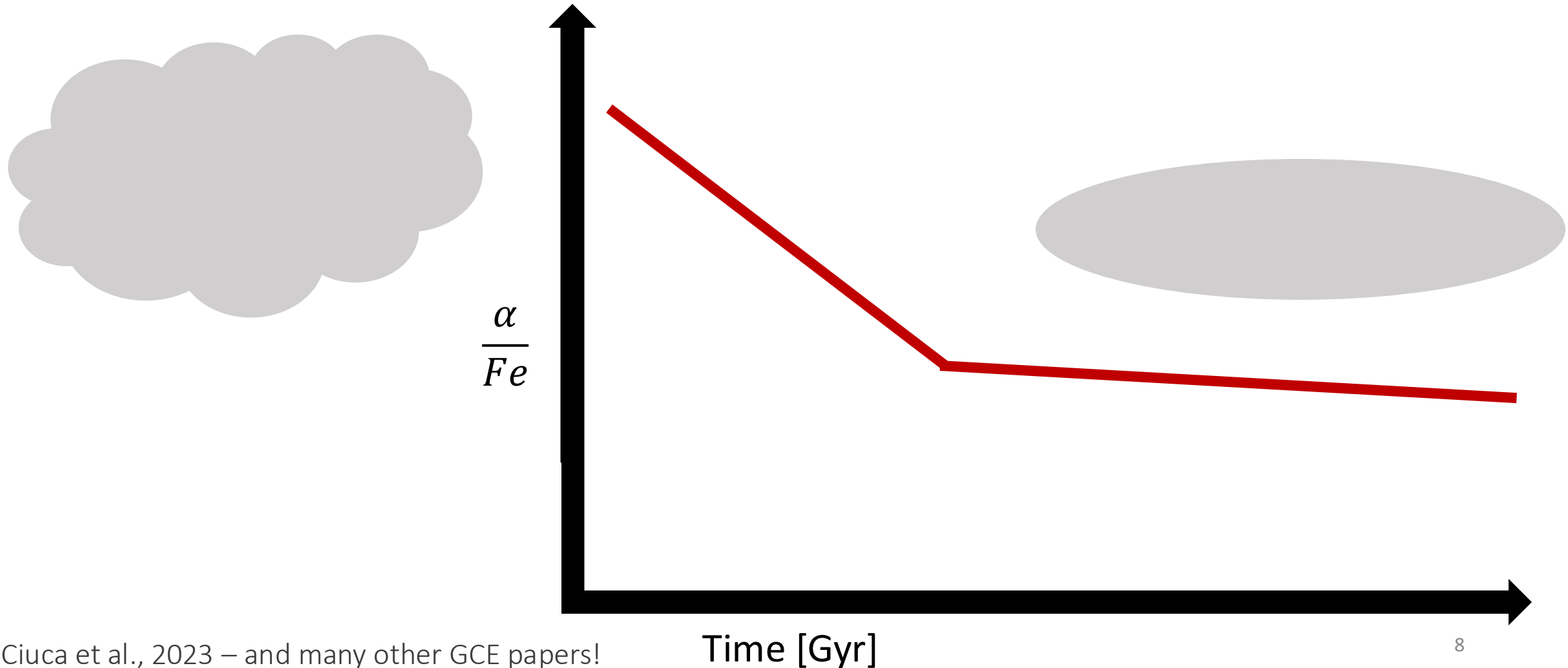

Galactic Chemical Evolution

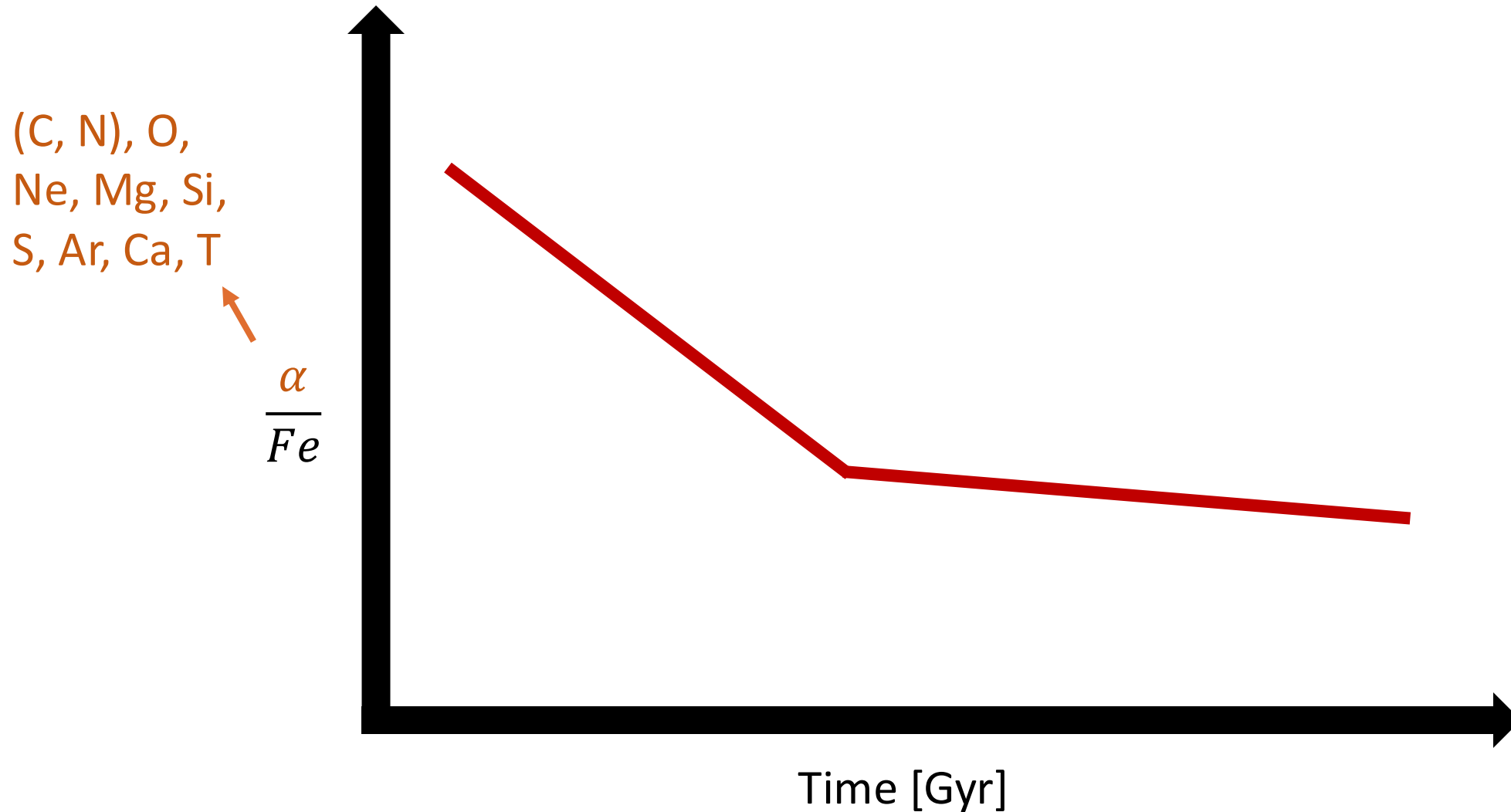

Galactic Chemical Evolution

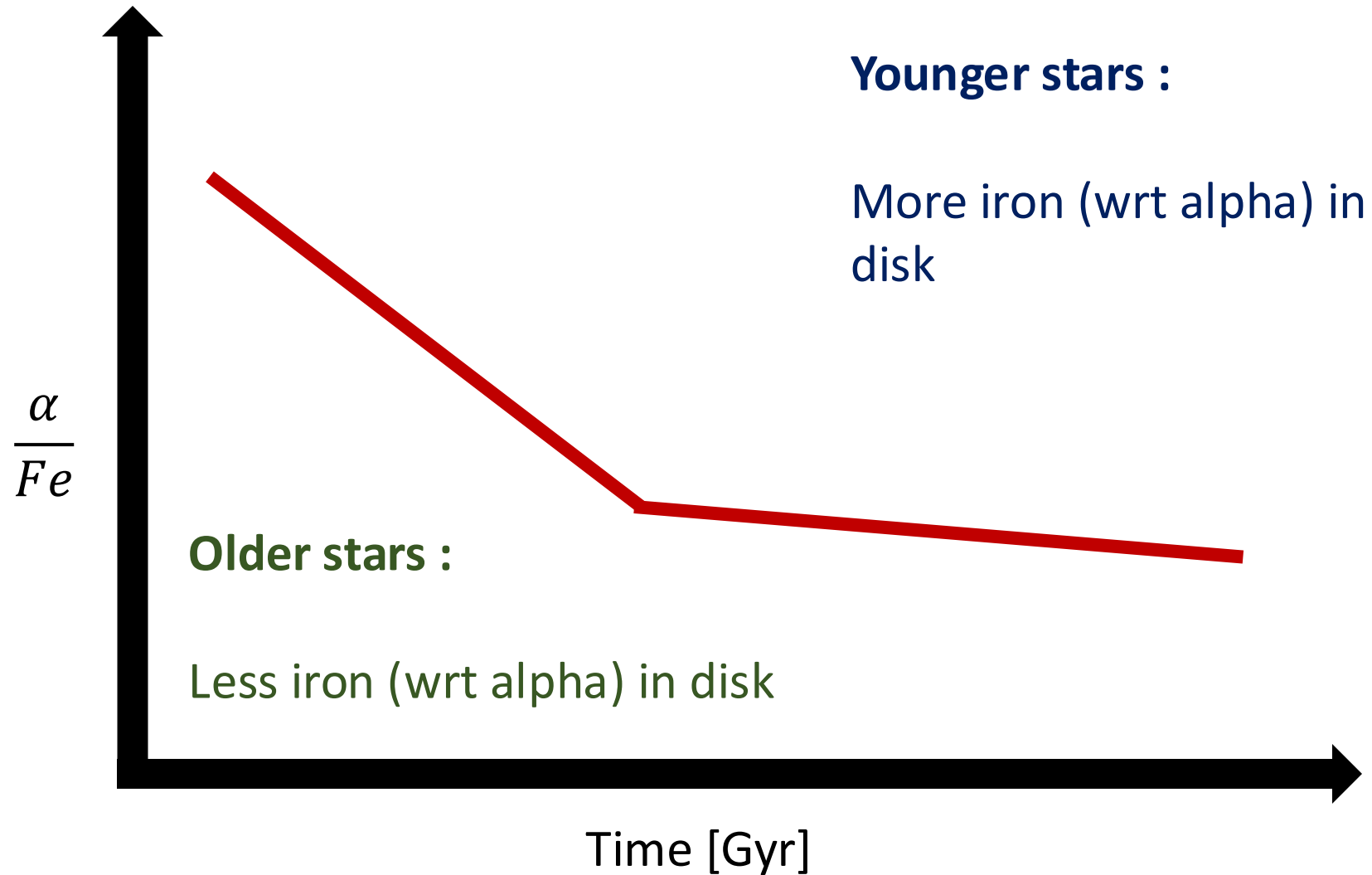

Does the Galactic Context link to Planet Properties?

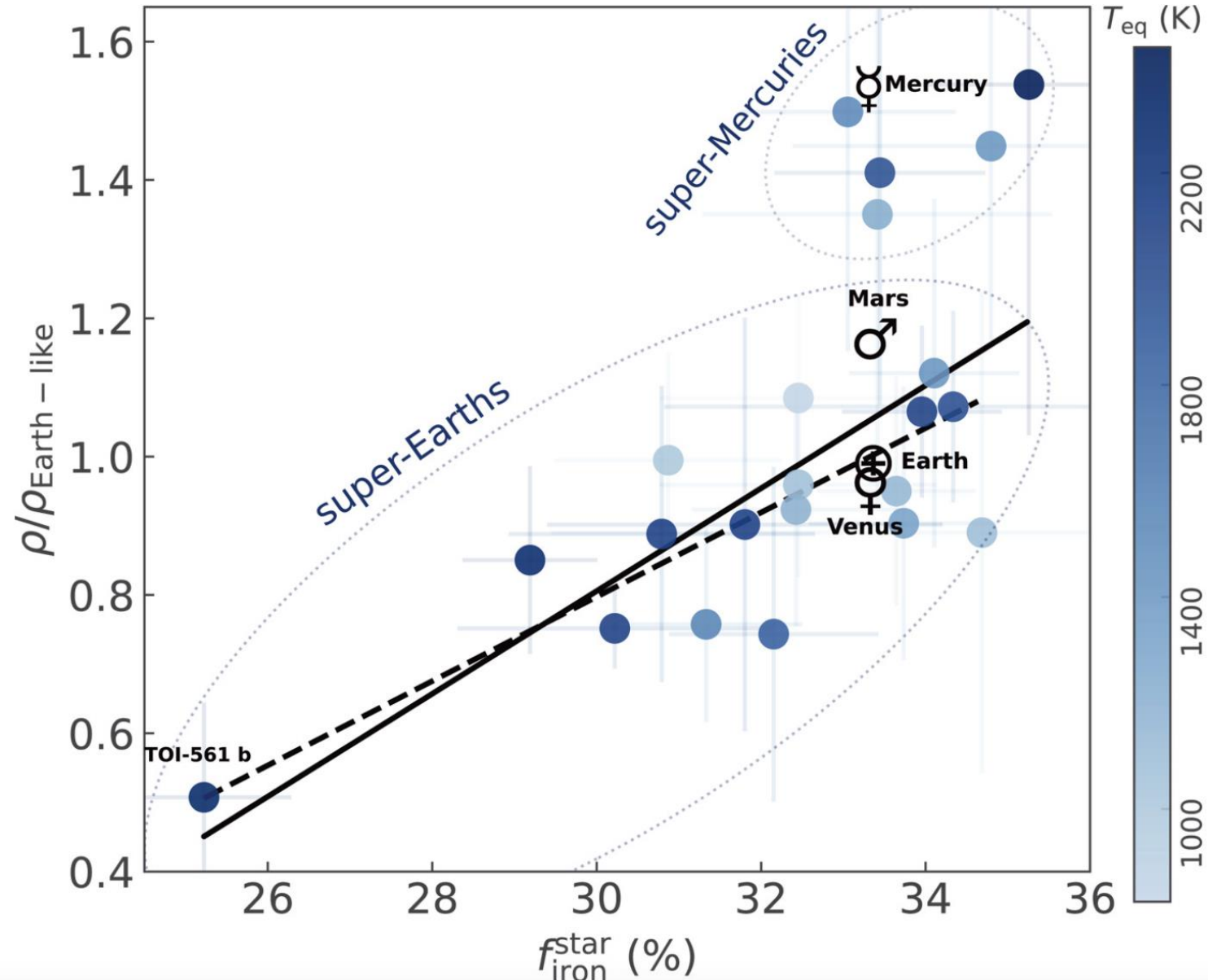

Homogeneous Host Star Parameters

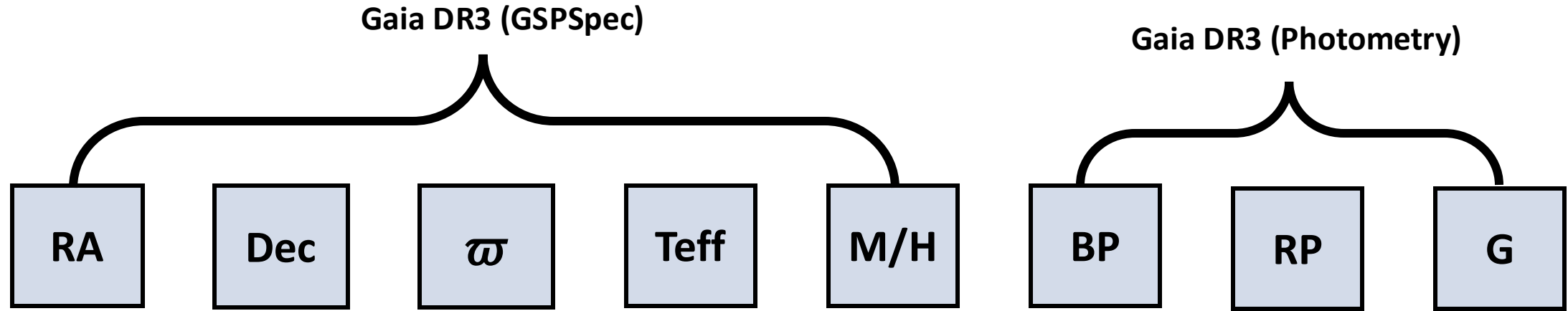

Homogeneous Host Star Parameters

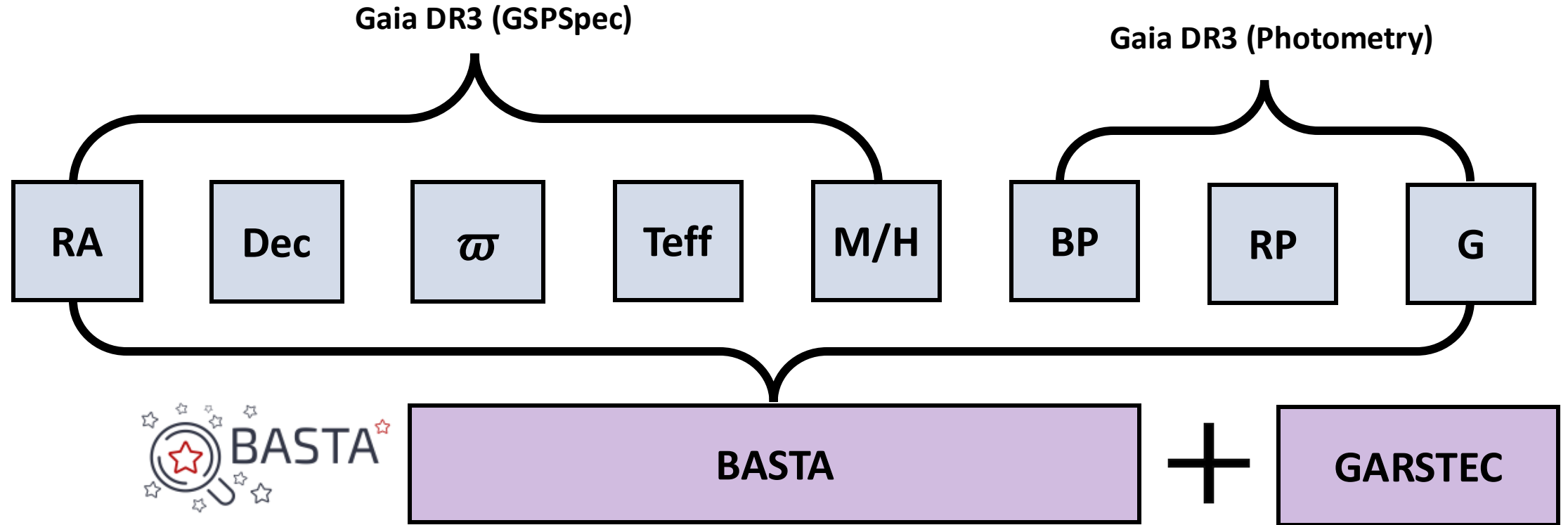

BASTA

+

GARSTEC

Homogeneous Host Star Parameters

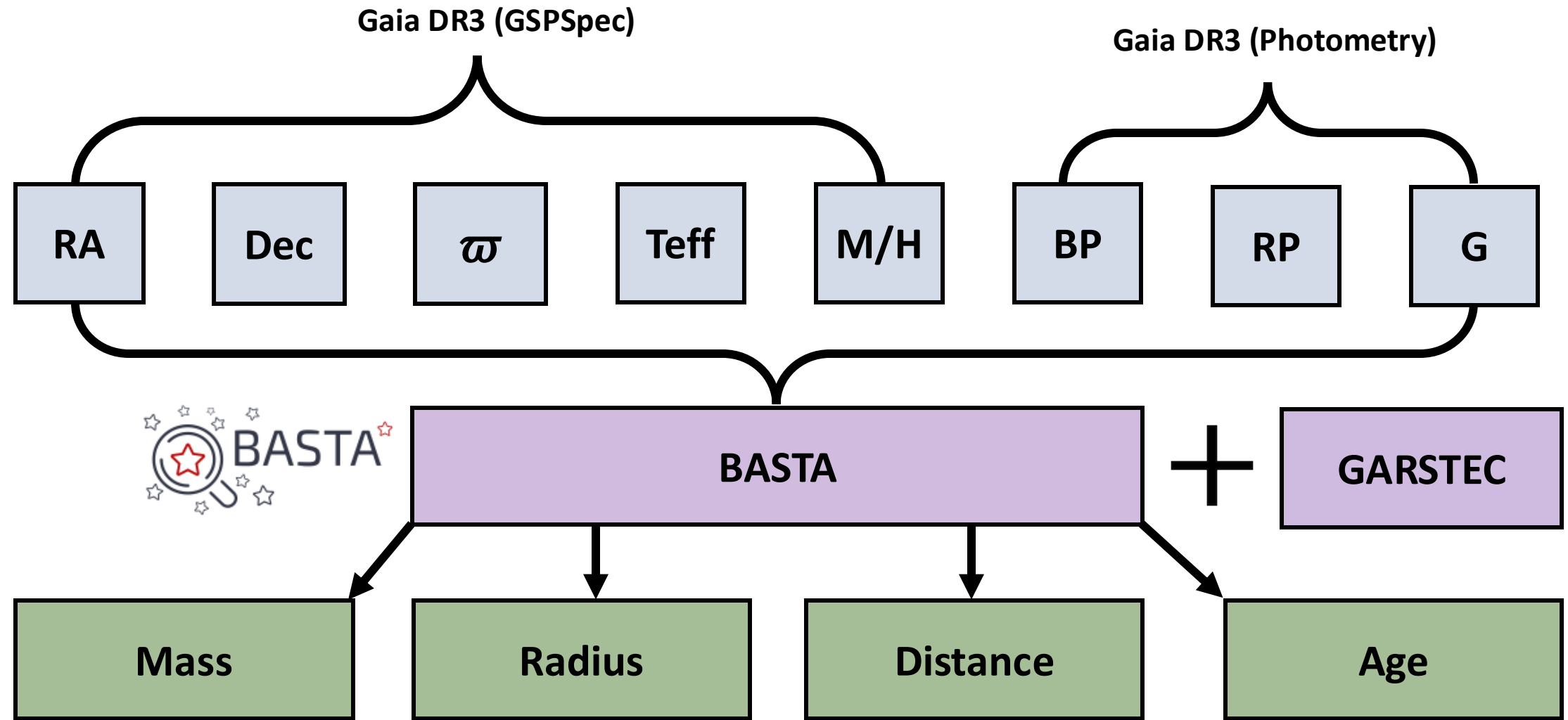

Homogeneous Host Star Parameters

Mass

Radius

Distance

Age

Homogeneous Host Star Parameters

Star

Mass

Radius

Distance

Age

Homogeneous Host Star Parameters

Star

Mass

Radius

Distance

Age

Homogeneous Host Star Parameters

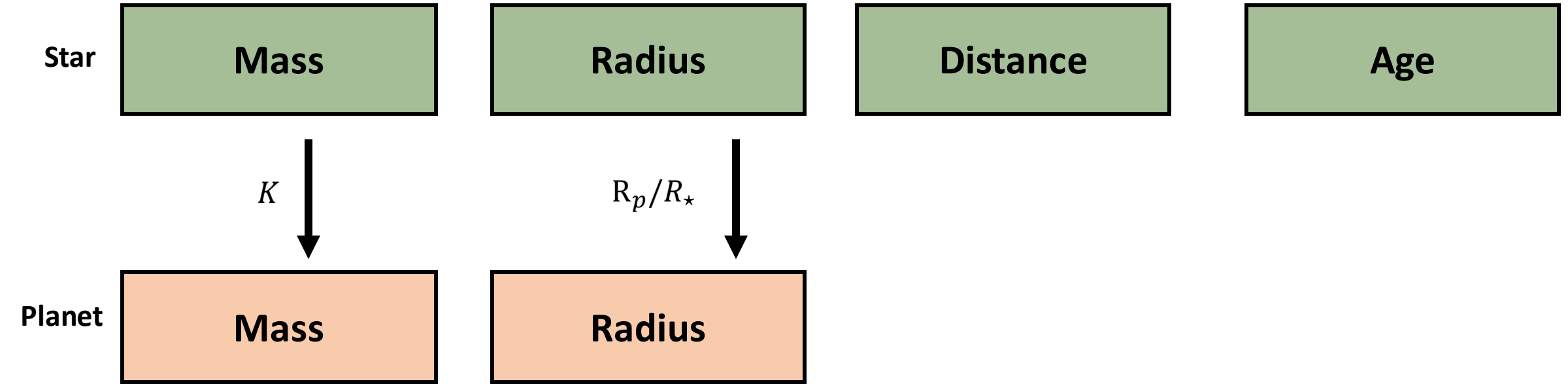

Homogeneous Host Star Parameters

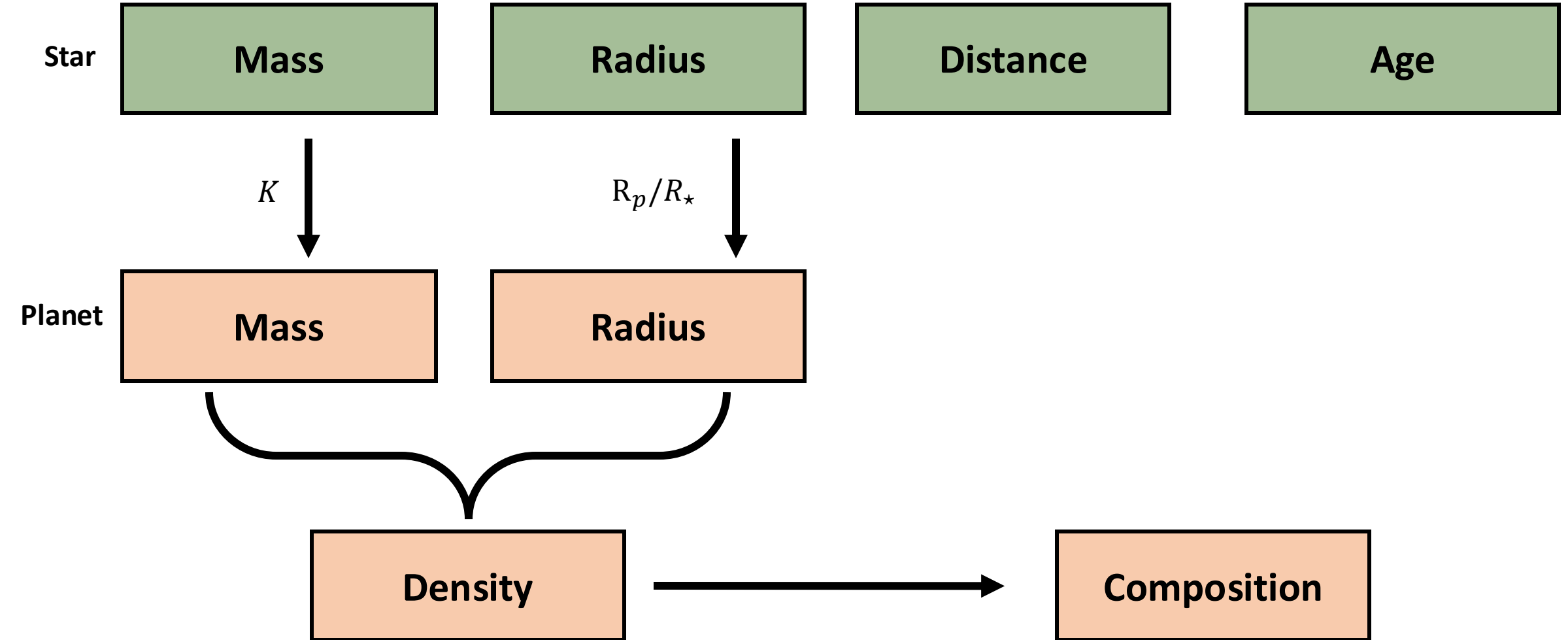

Homogeneous Host Star Parameters

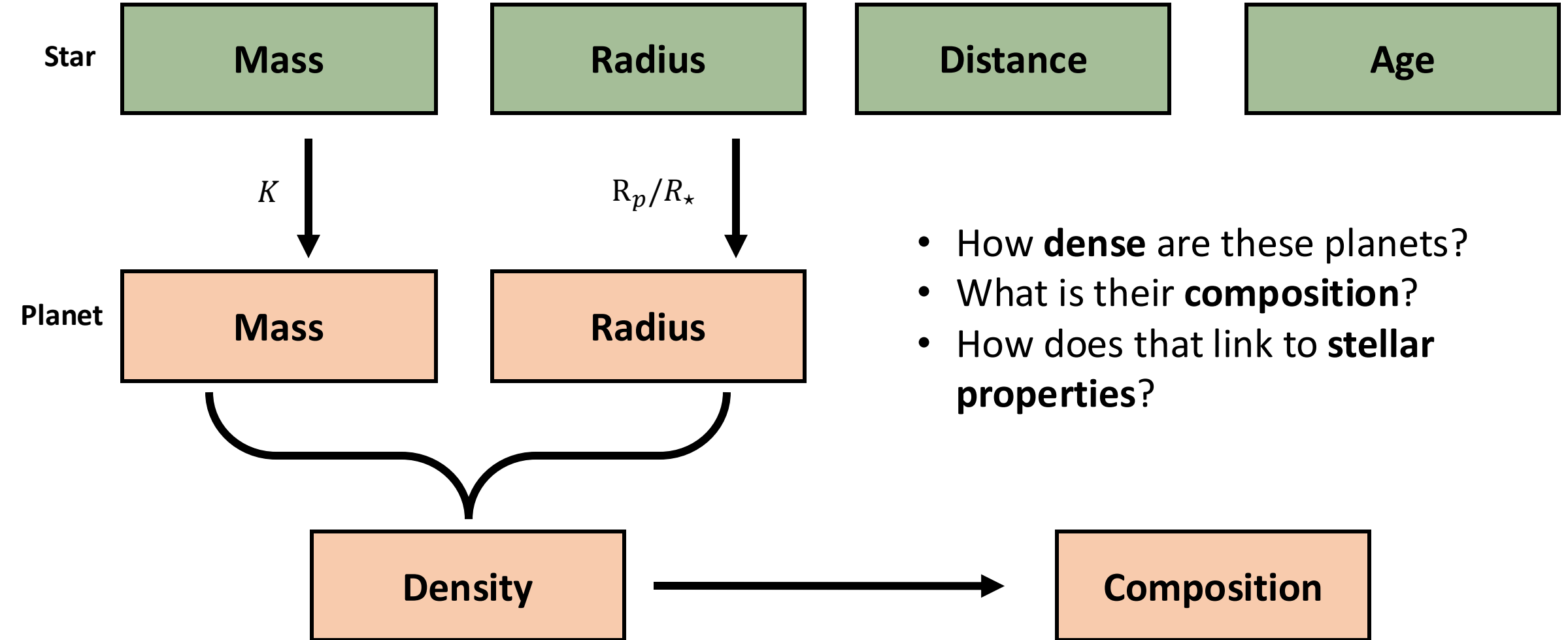

Homogeneous Host Star Parameters

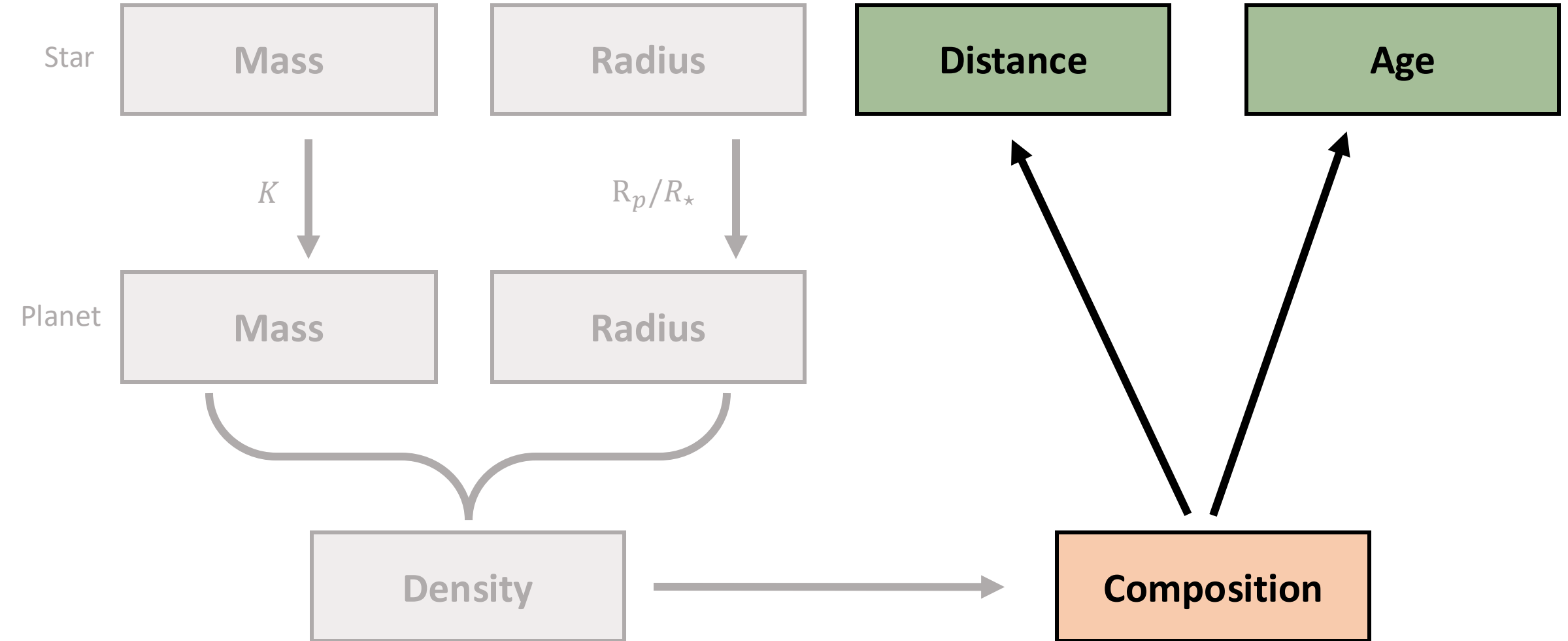

Younger stars host denser rocky planets

Weeks+ 2024

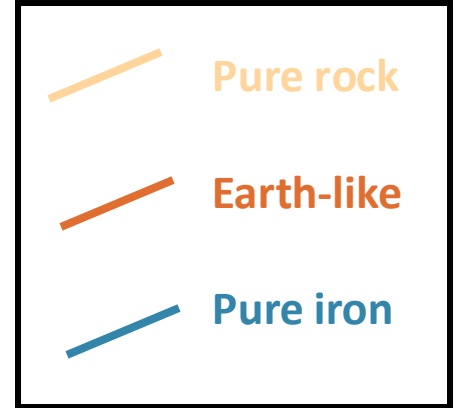
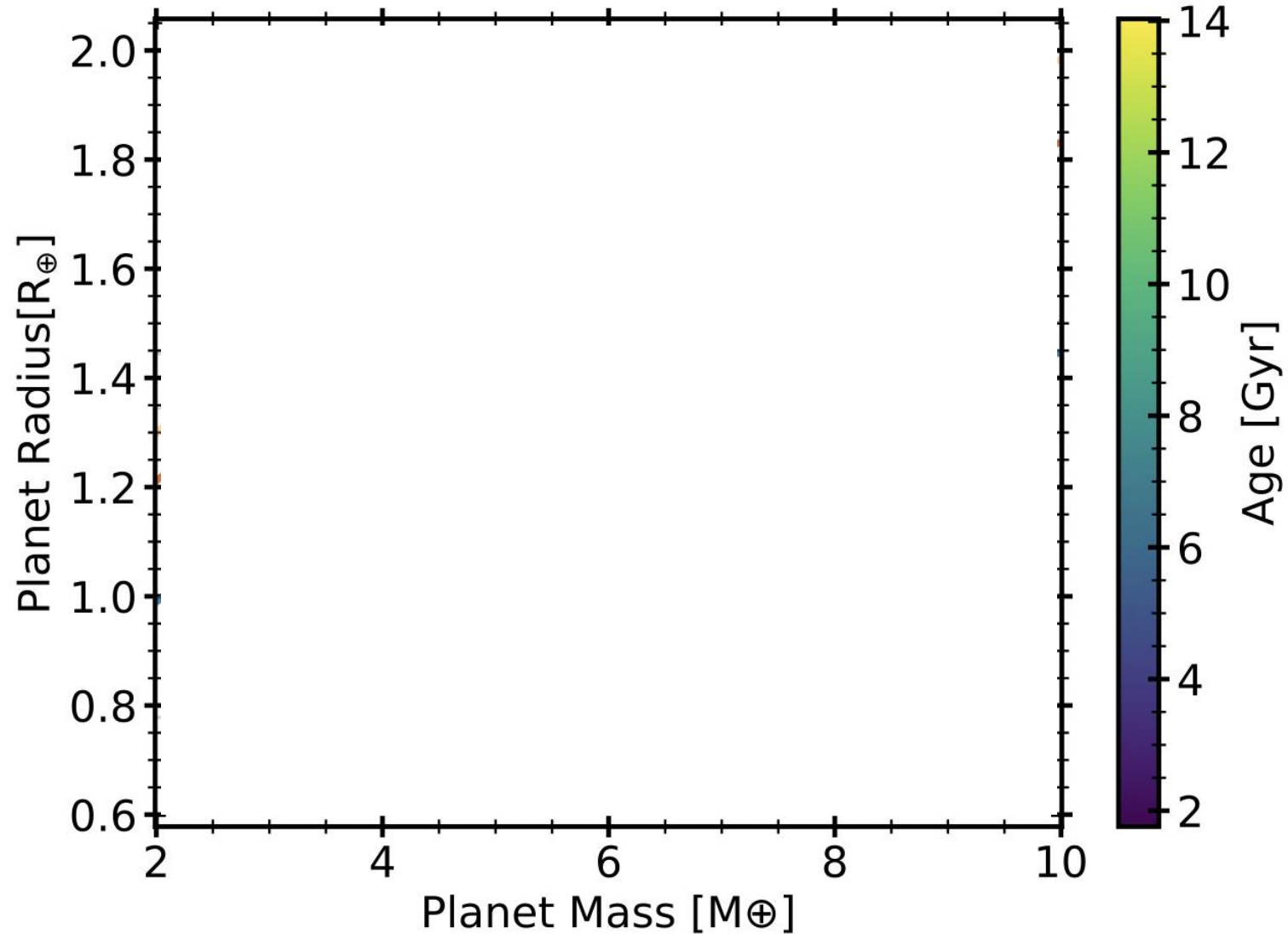

Younger stars host denser rocky planets

Weeks+ 2024

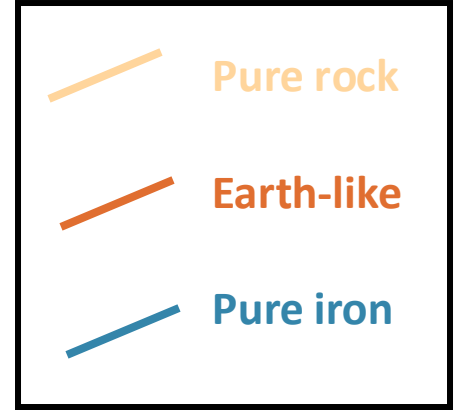
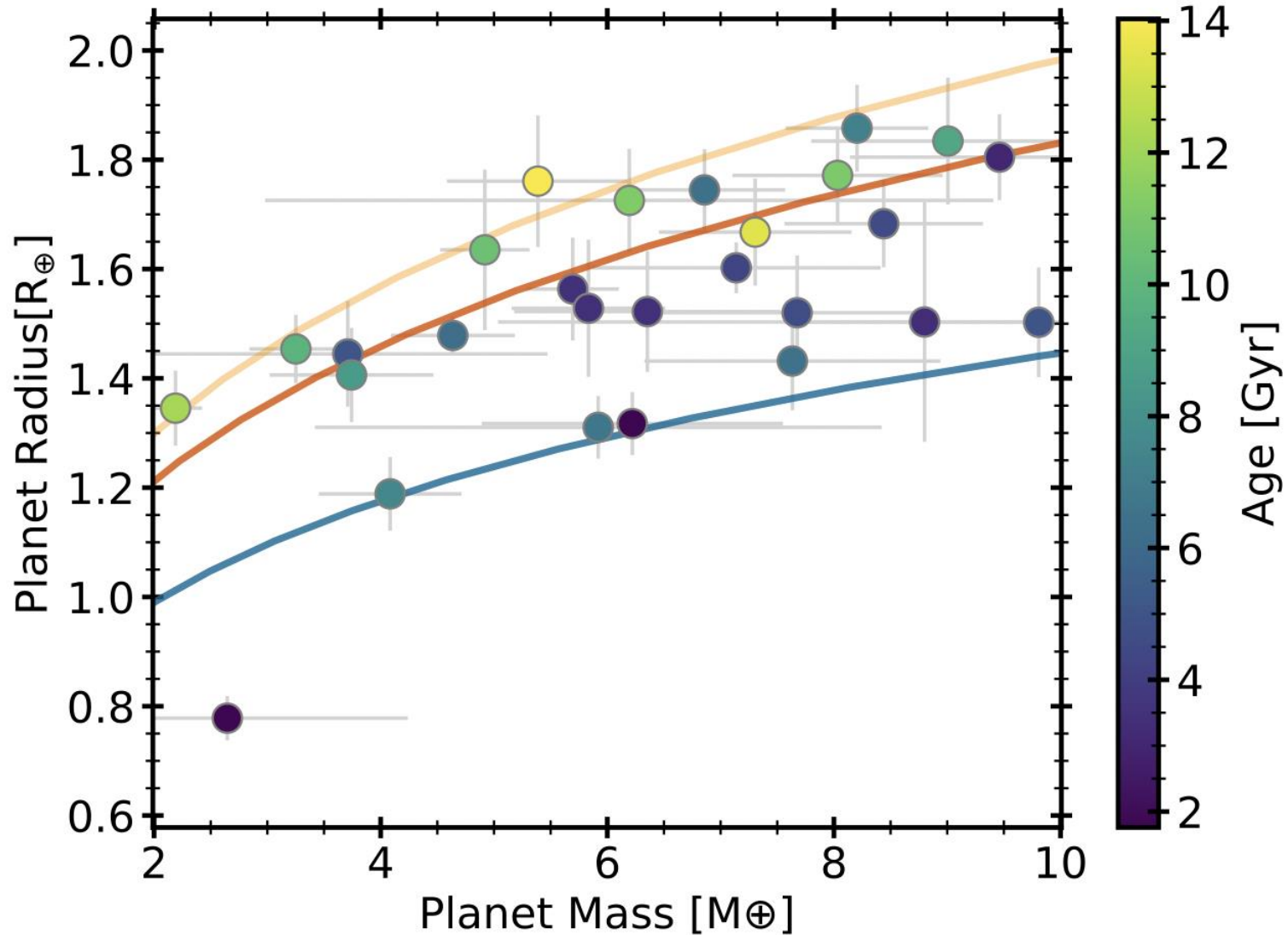

Younger stars host denser rocky planets

Weeks+ 2025a (in Prep)

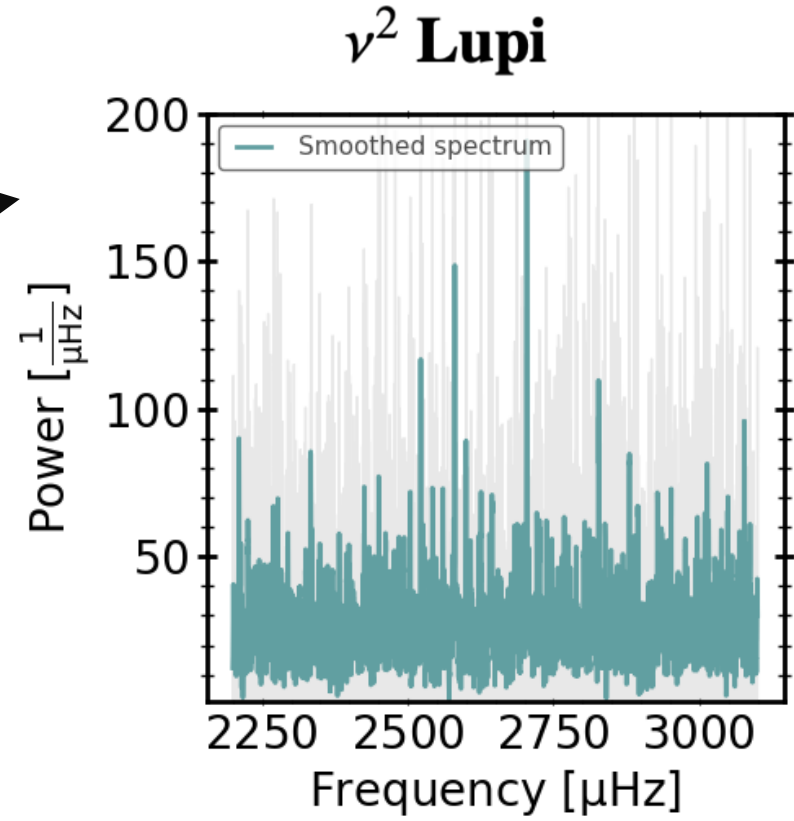
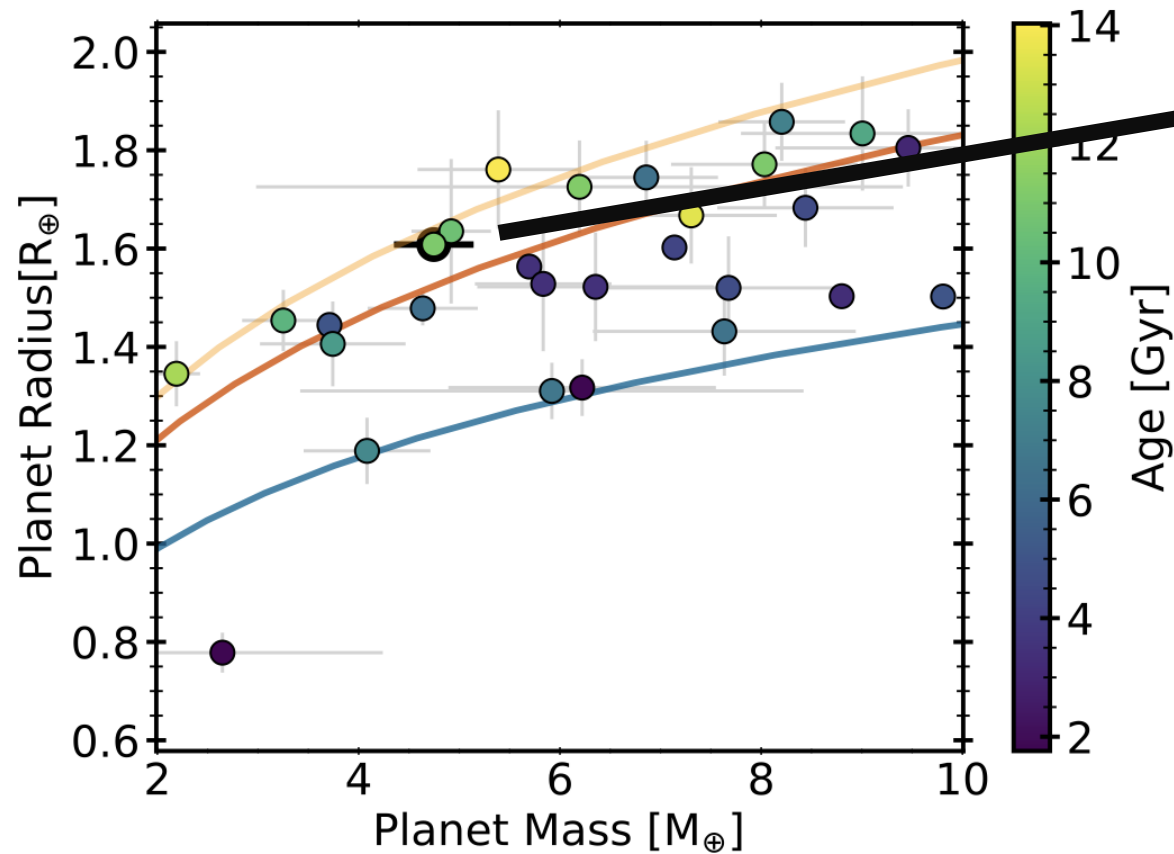

Younger stars host denser rocky planets

Weeks+ 2024

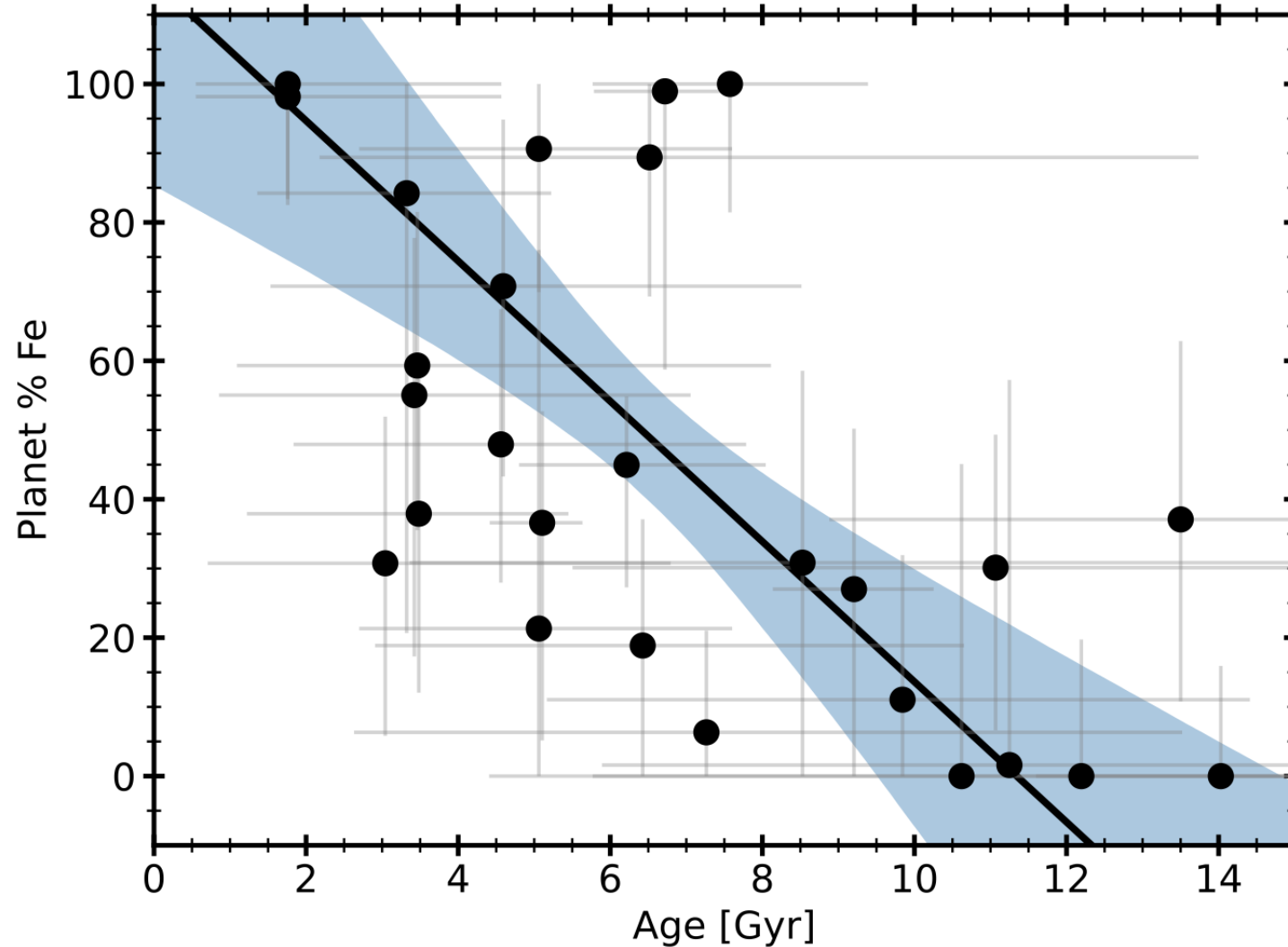

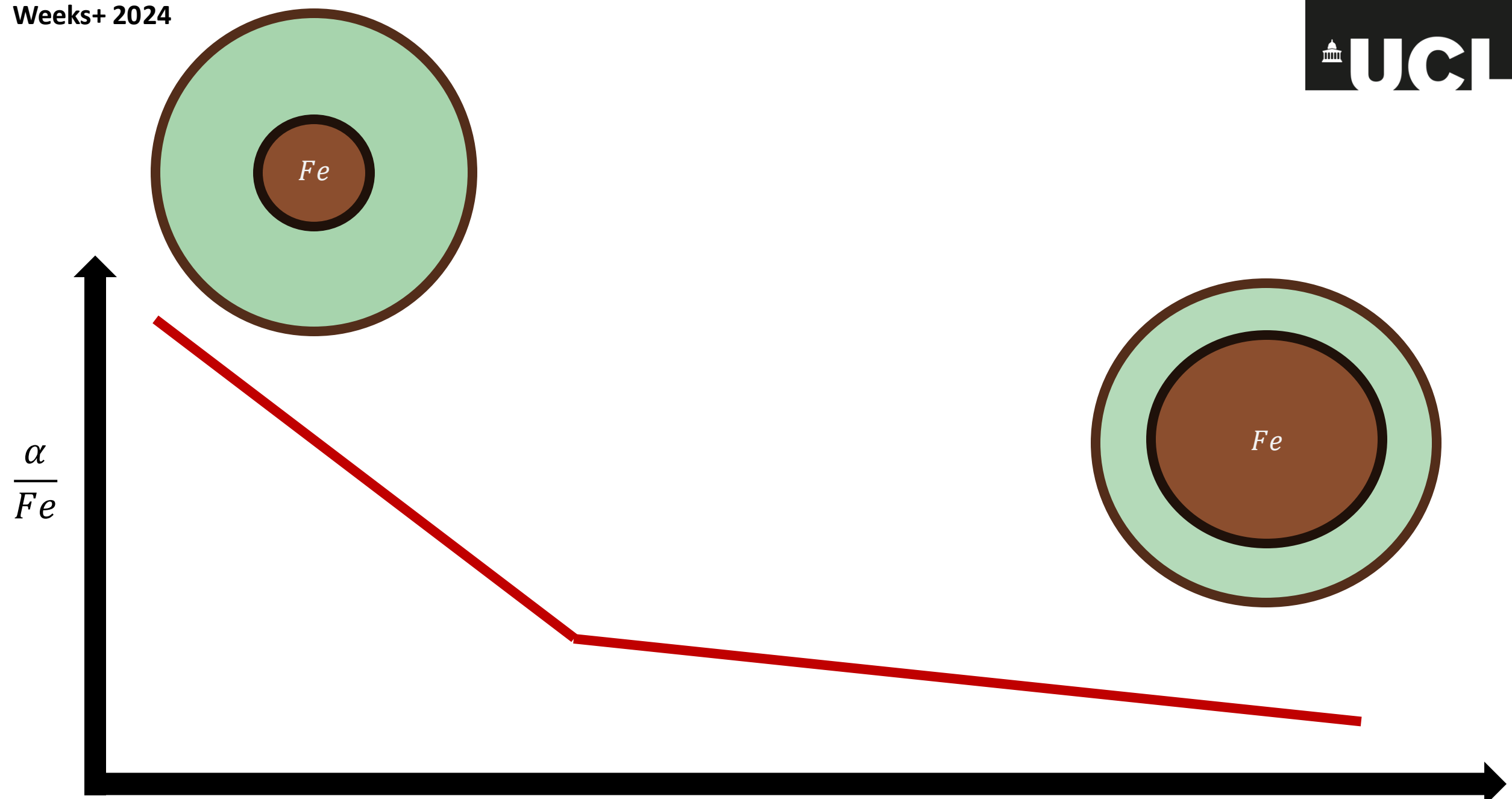

e.g. Bedell et al., 2016,2019

Time [Gyr]

A Link between Rocky Planet Composition and Stellar Age

Angharad Weeks,^{1,2*} Vincent Van Eylen¹, Daniel Huber,^{2,3} Daisuke Kawata,¹ Amalie Stokholm,^{4,5}
 Victor Aguirre Børsen-Koch,⁶ Paola Pinilla,¹ Jakob Lysgaard Rørsted,^{5,7} Mark Lykke Winther,⁵ Travis Berger⁸

[arXiv:2411.17358](https://arxiv.org/abs/2411.17358)

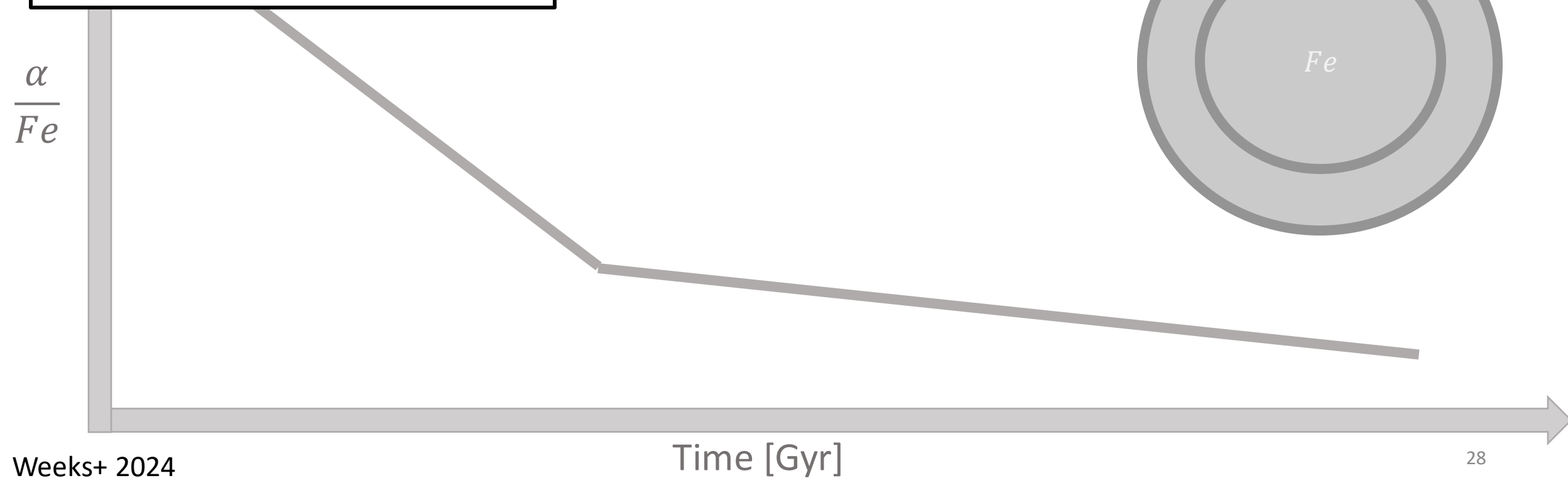

The Radius Valley

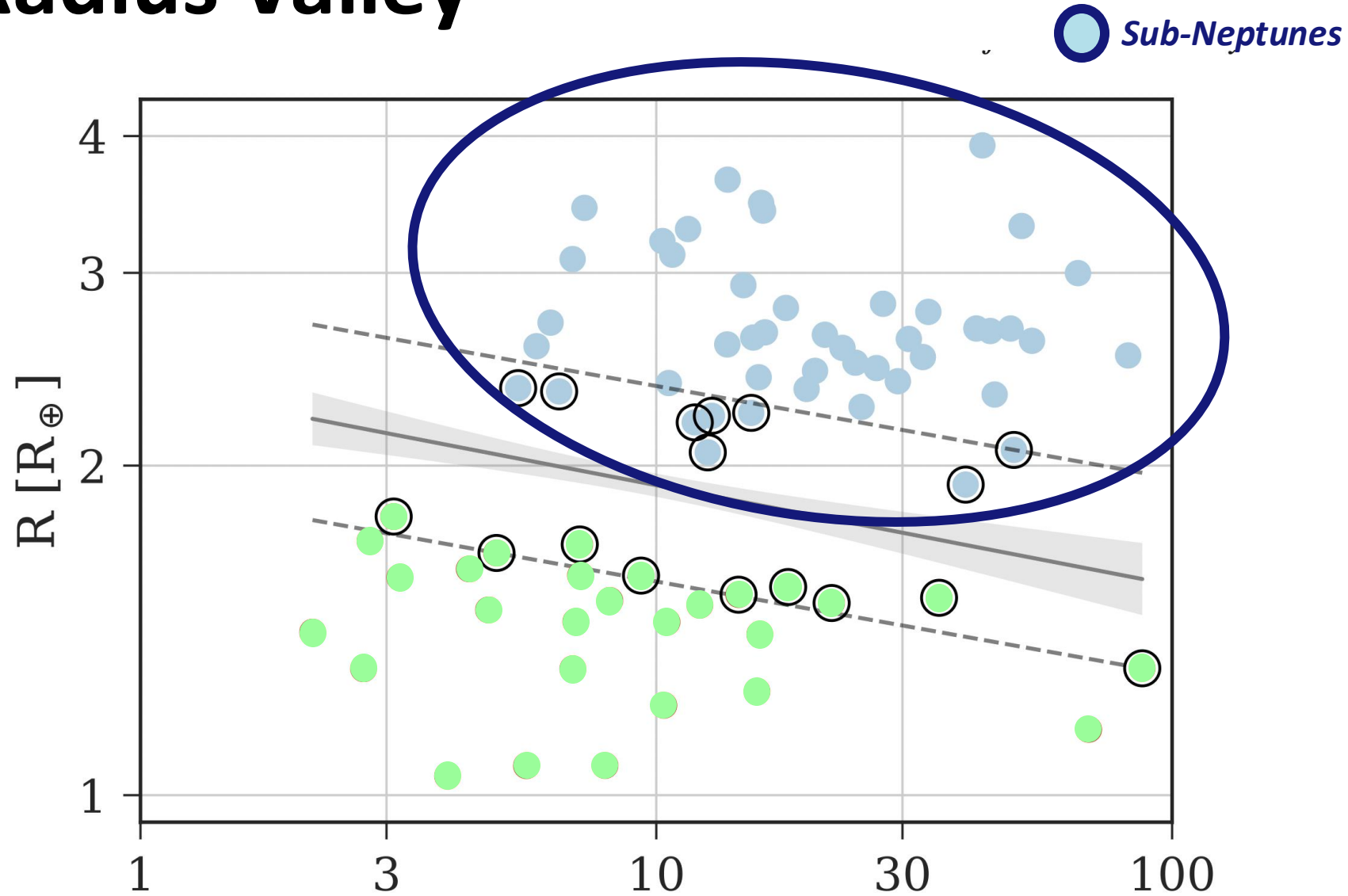

 Super-Earths

Sub-Neptune planets?

Does *this* link
to these
elements in
the Galaxy?

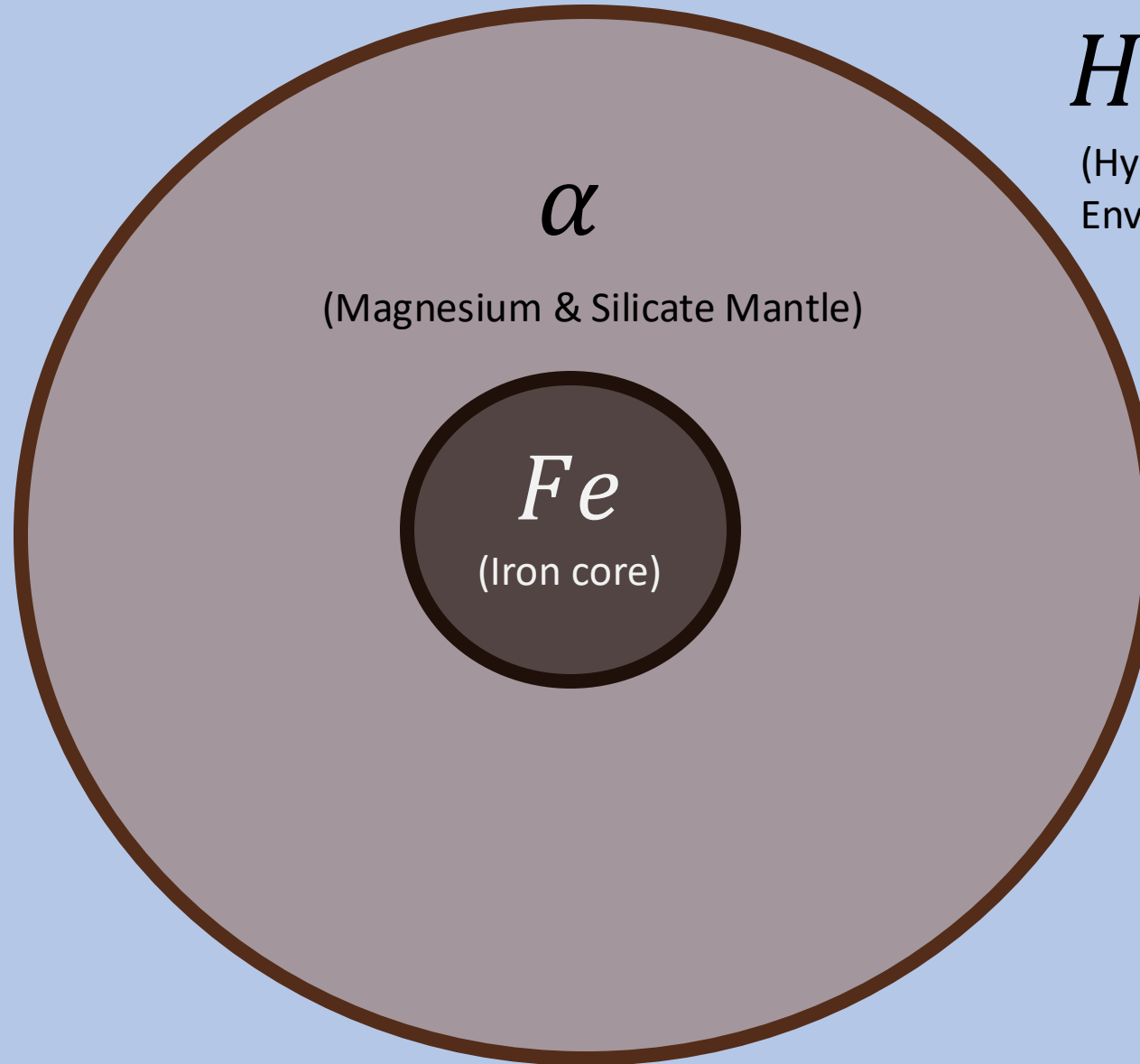

H/He
(Hydrogen & Helium
Envelope)

α

(Magnesium & Silicate Mantle)

Fe

(Iron core)

Homogeneous stellar parameters of sub-Neptunes

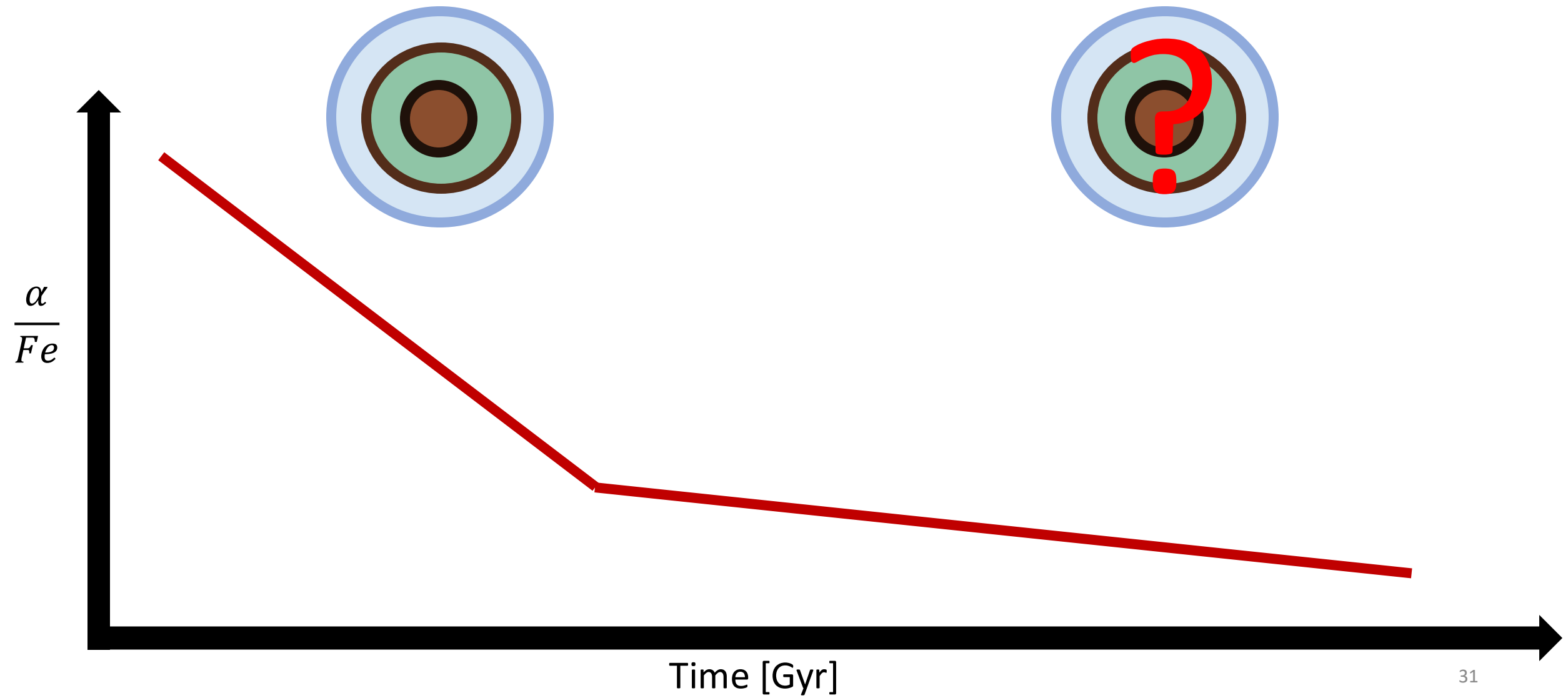

Sub-Neptunes

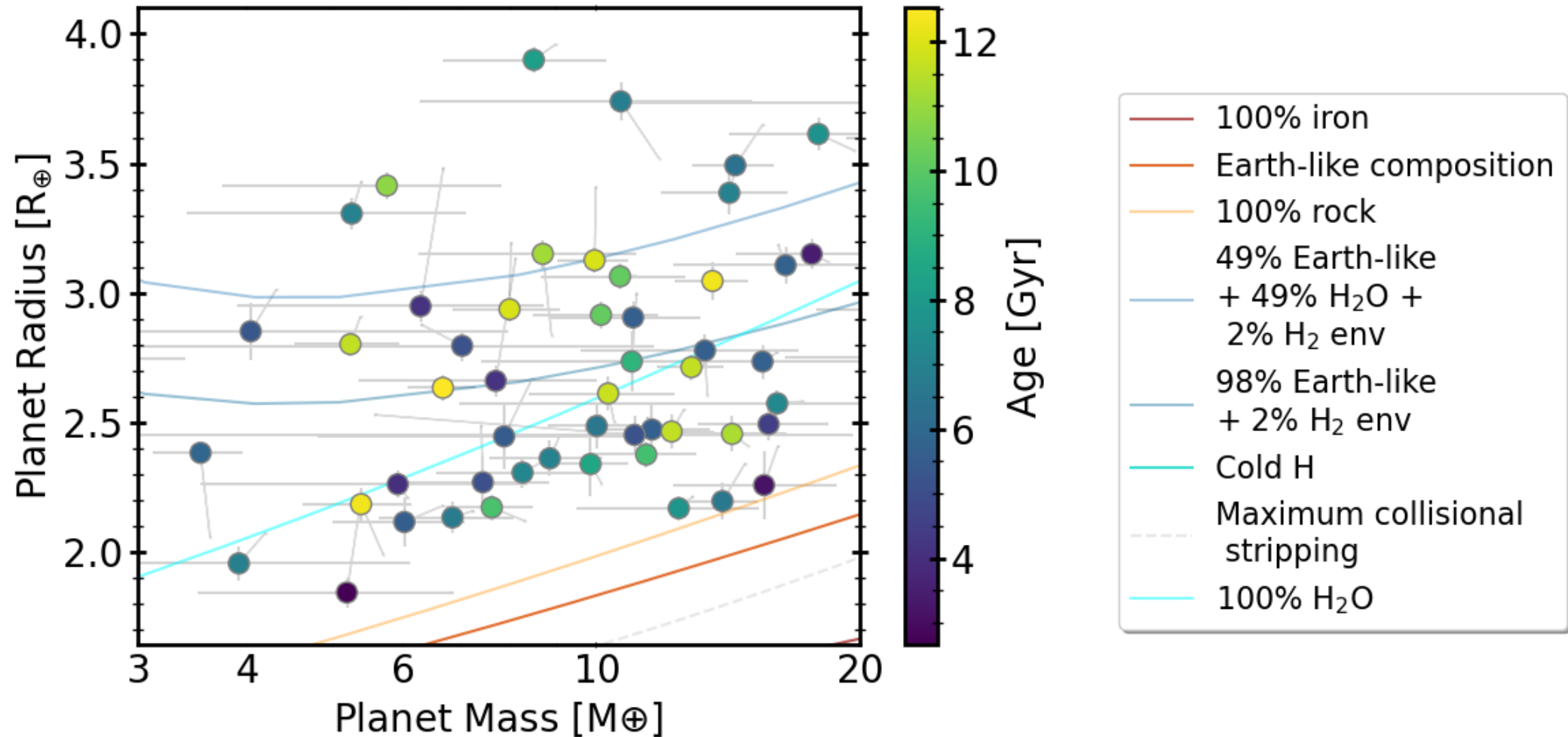

The Galactic Context

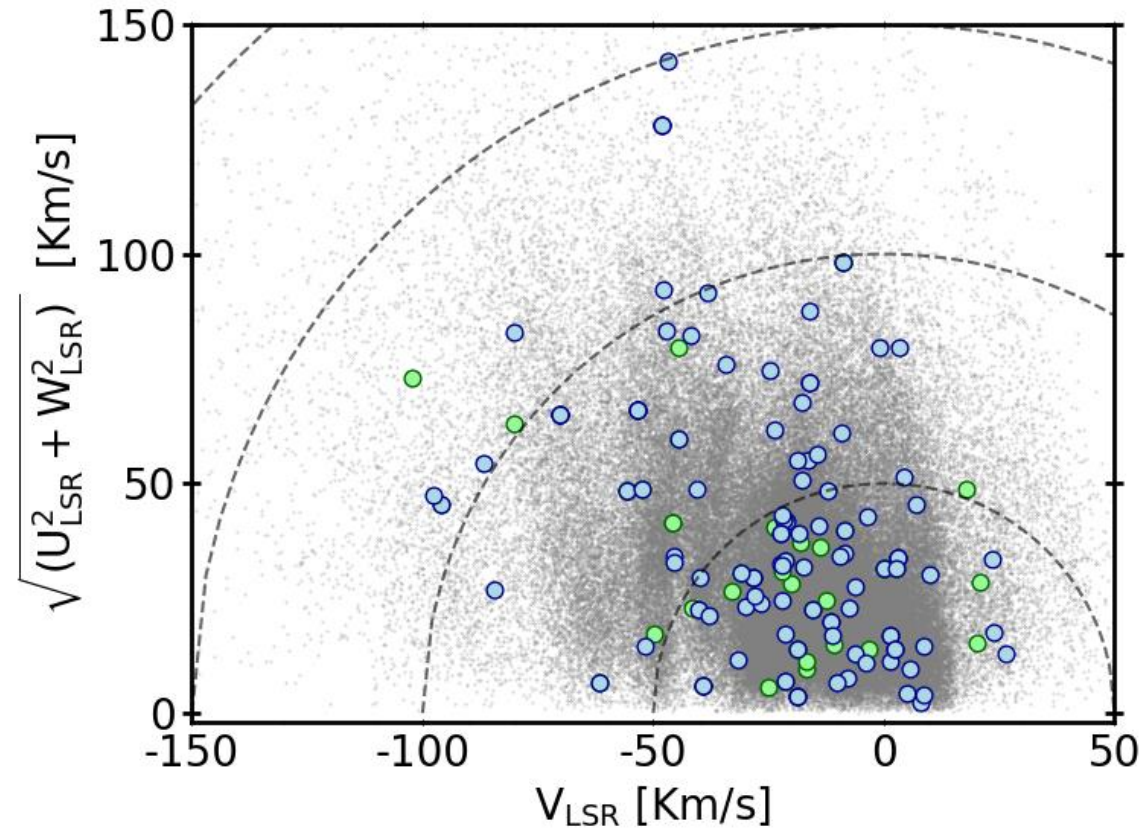

 *Sub-Neptunes*

 *Super-Earths*

The Galactic Context

~ Thick Disk

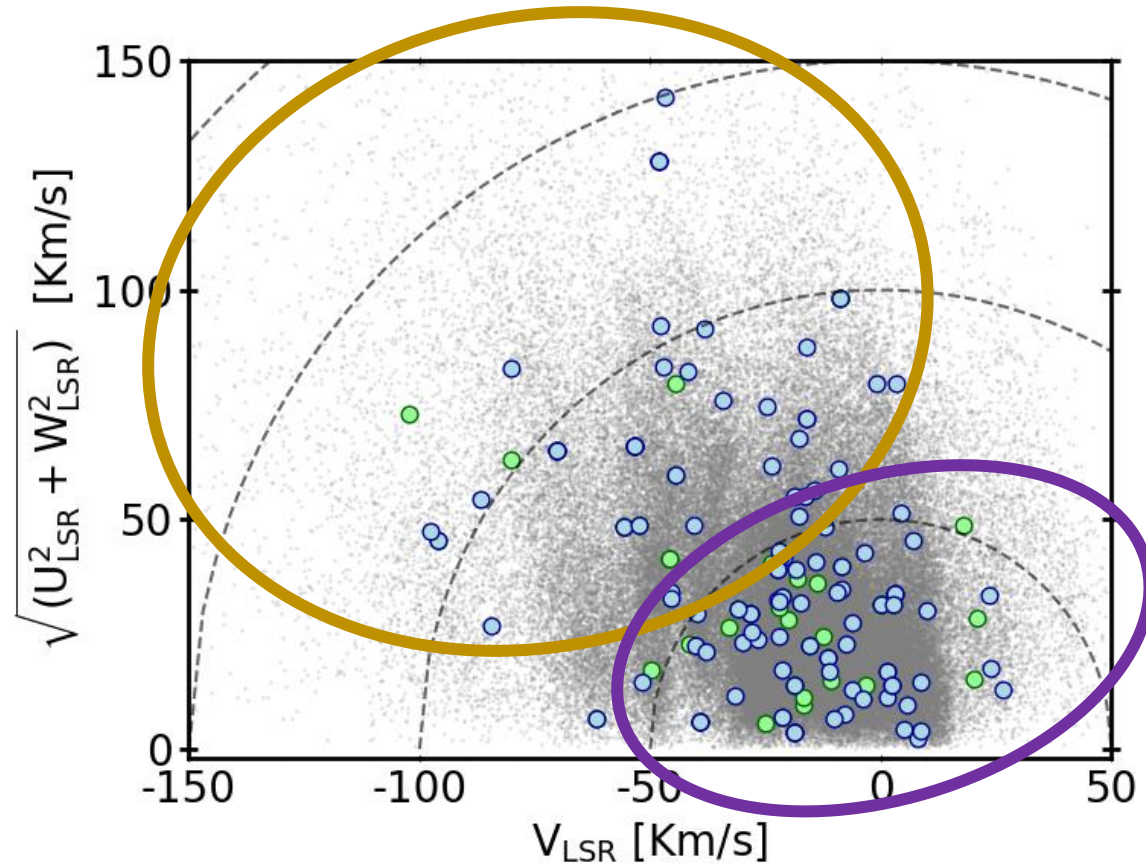

~ Thin Disk

 *Sub-Neptunes*

 *Super-Earths*

The Galactic Context

~ Thick Disk

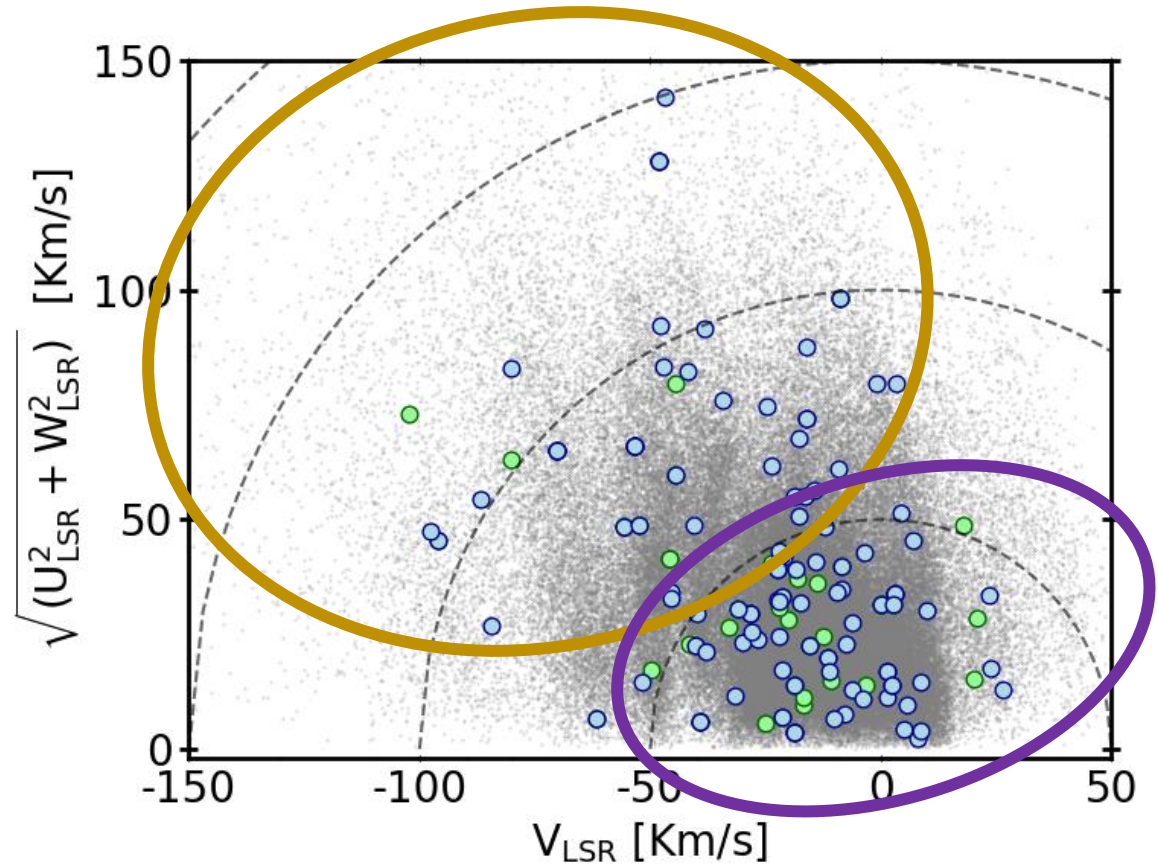

~ Thin Disk

 *Sub-Neptunes*

 *Super-Earths*

Weeks+ 2025b (in Prep) – A catalogue of Host Star Parameters from Gaia

Conclusions

- **More dense Super-Earths** tend to orbit around **younger stars**, which may be a result of **Galactic Chemical Evolution** processes
- **Sub-Neptune densities** don't exhibit such an obvious trend with age, indicating that the above trend is of galactic origin
- **Asteroseismology and PLATO** will help us further understand the galactic context of these small exoplanets ***(and we should do this homogeneously!)***

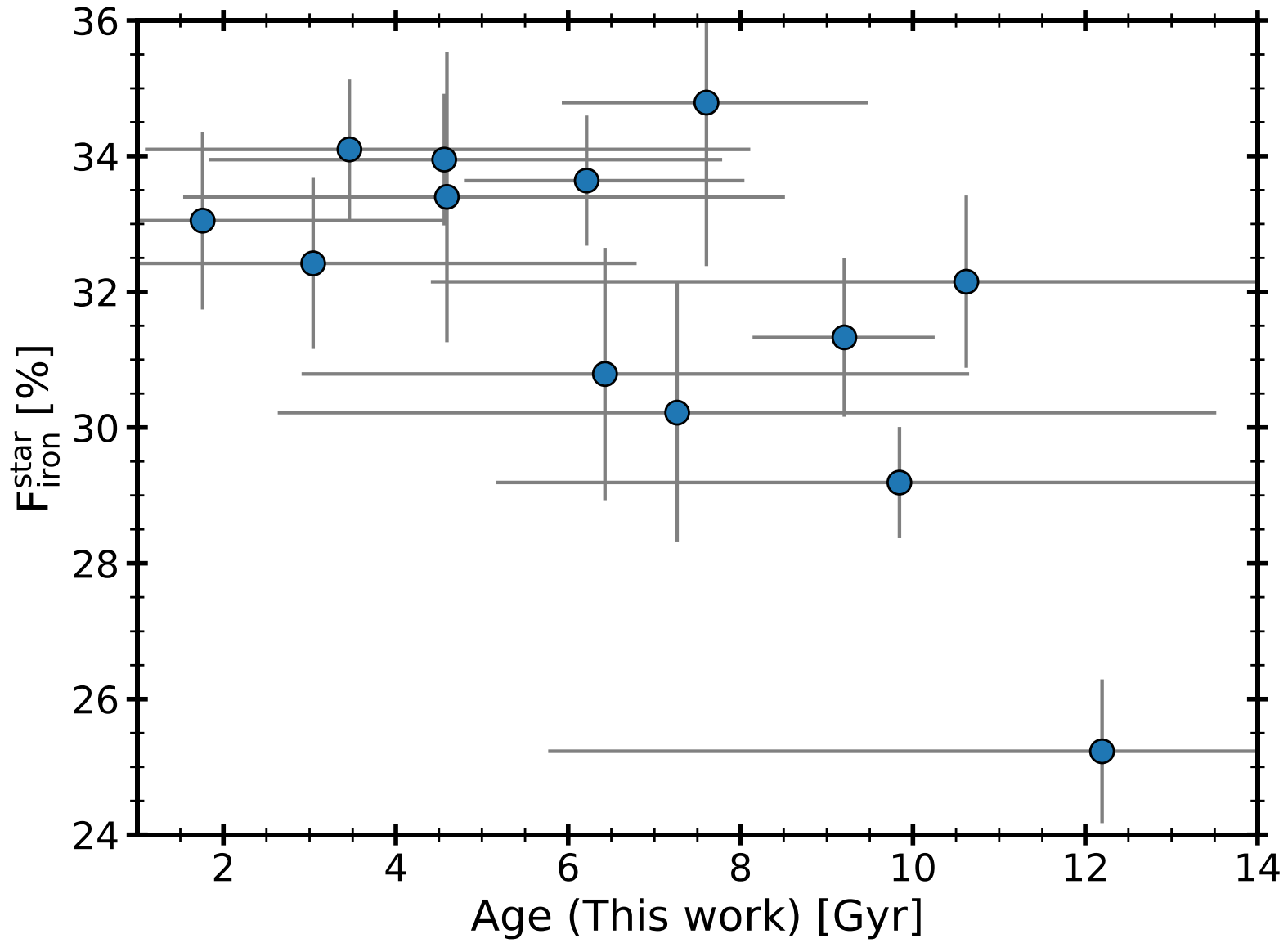

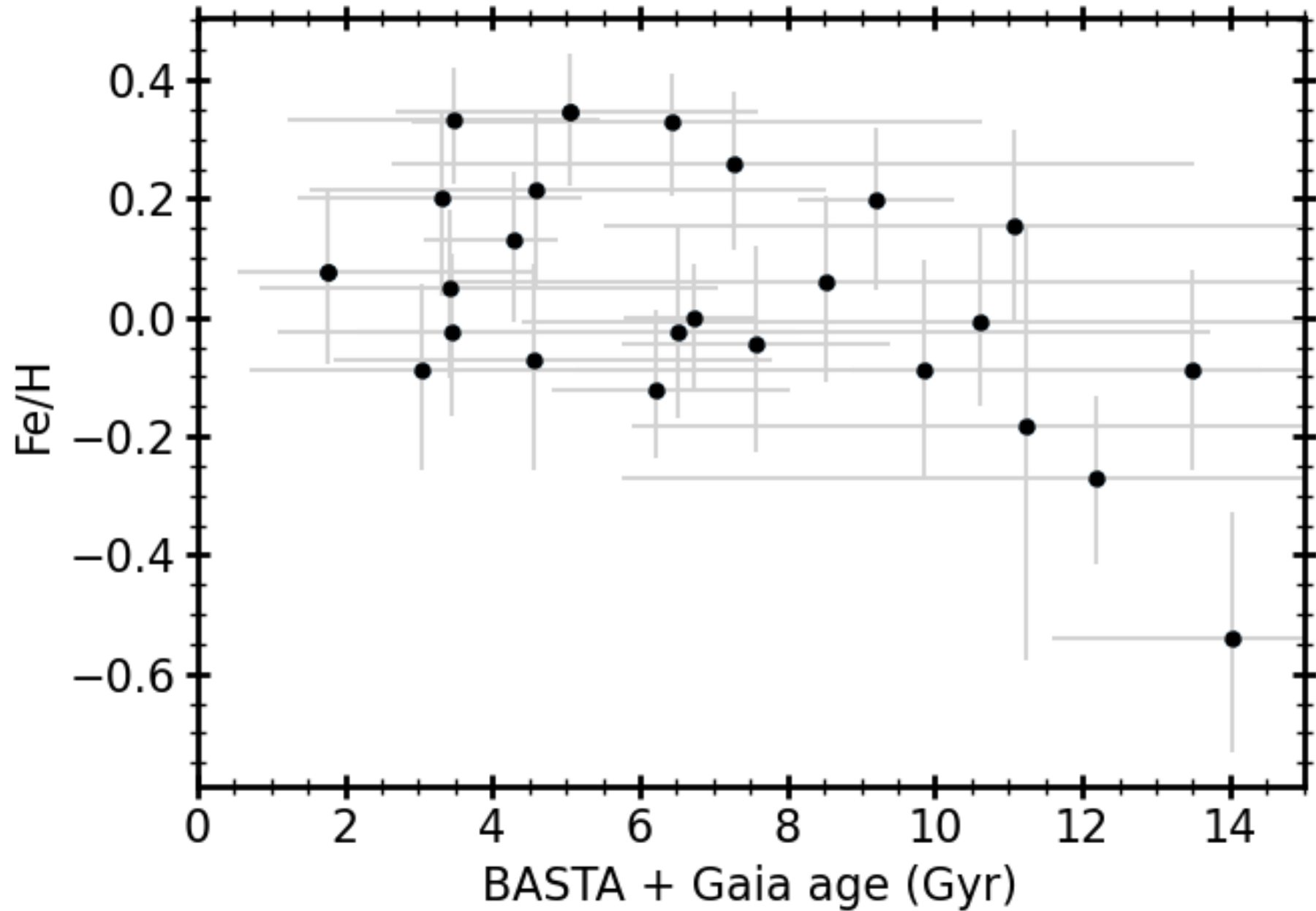

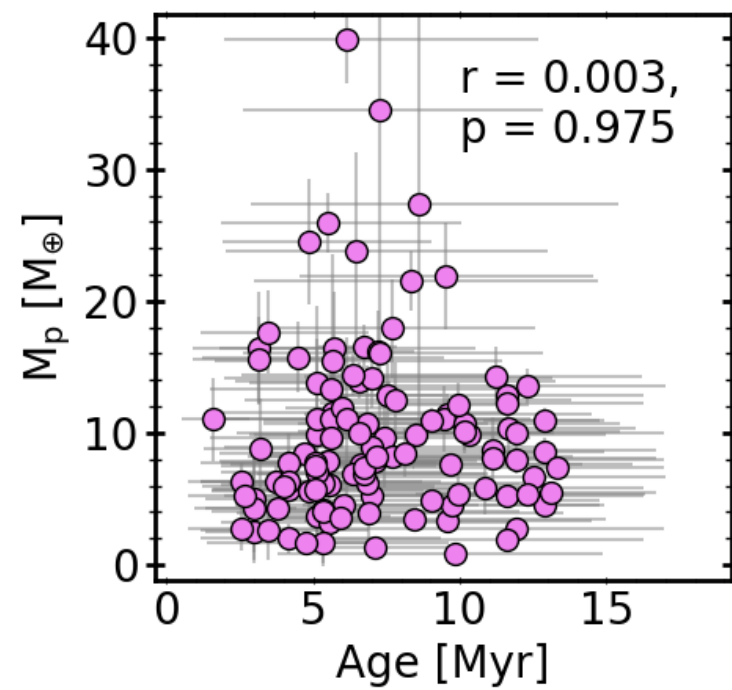
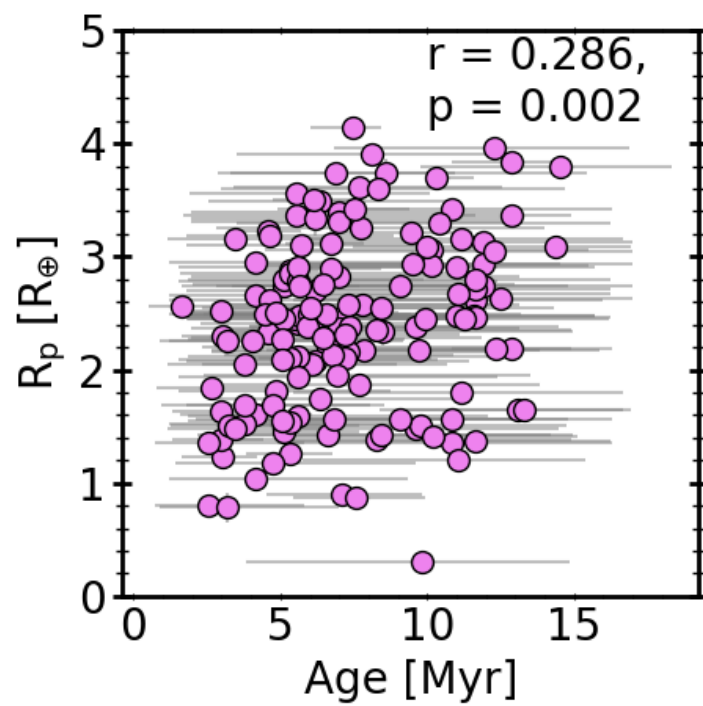
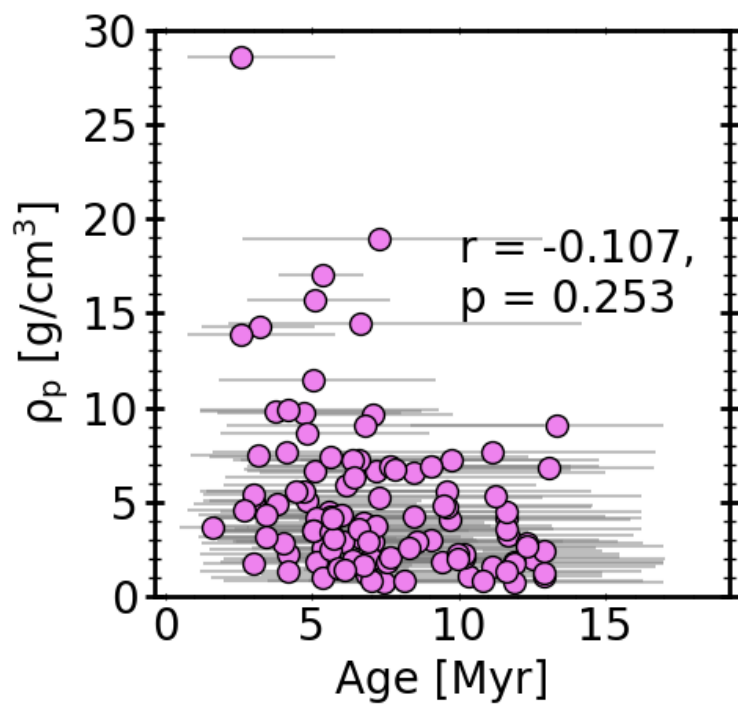

The Galactic Context

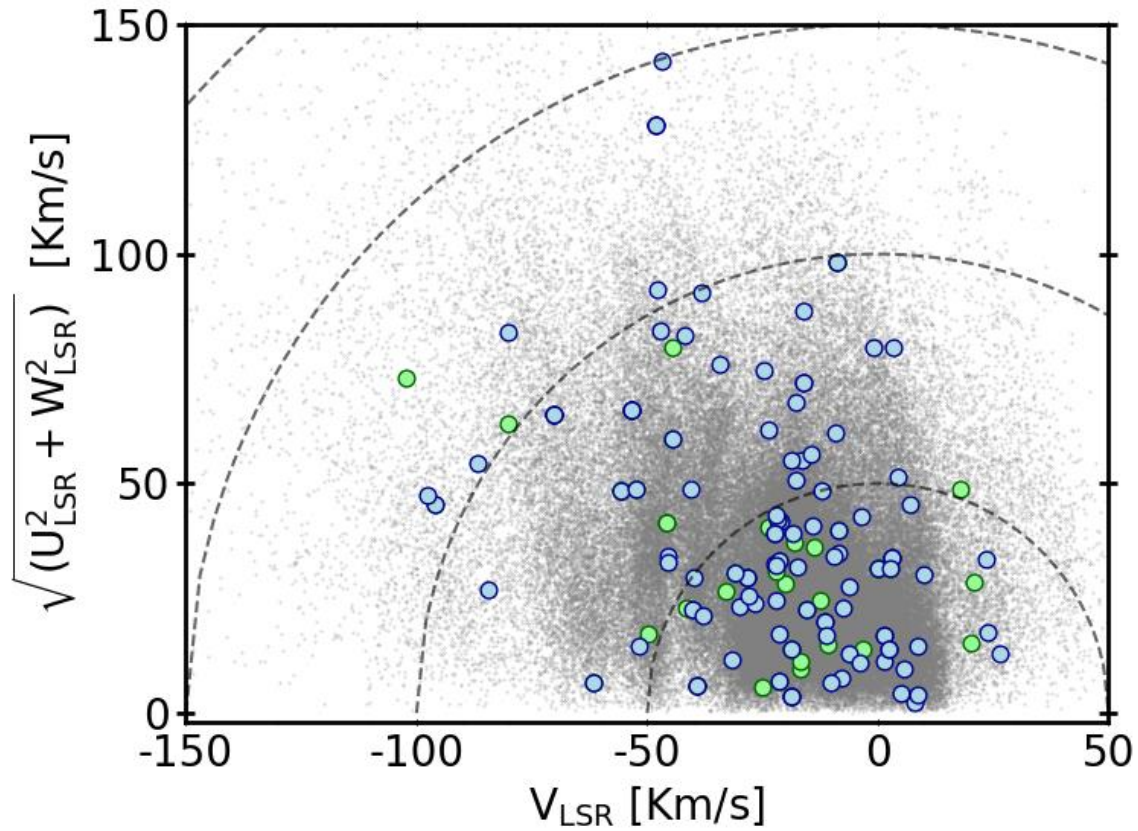

 *Sub-Neptunes*

 *Super-Earths*

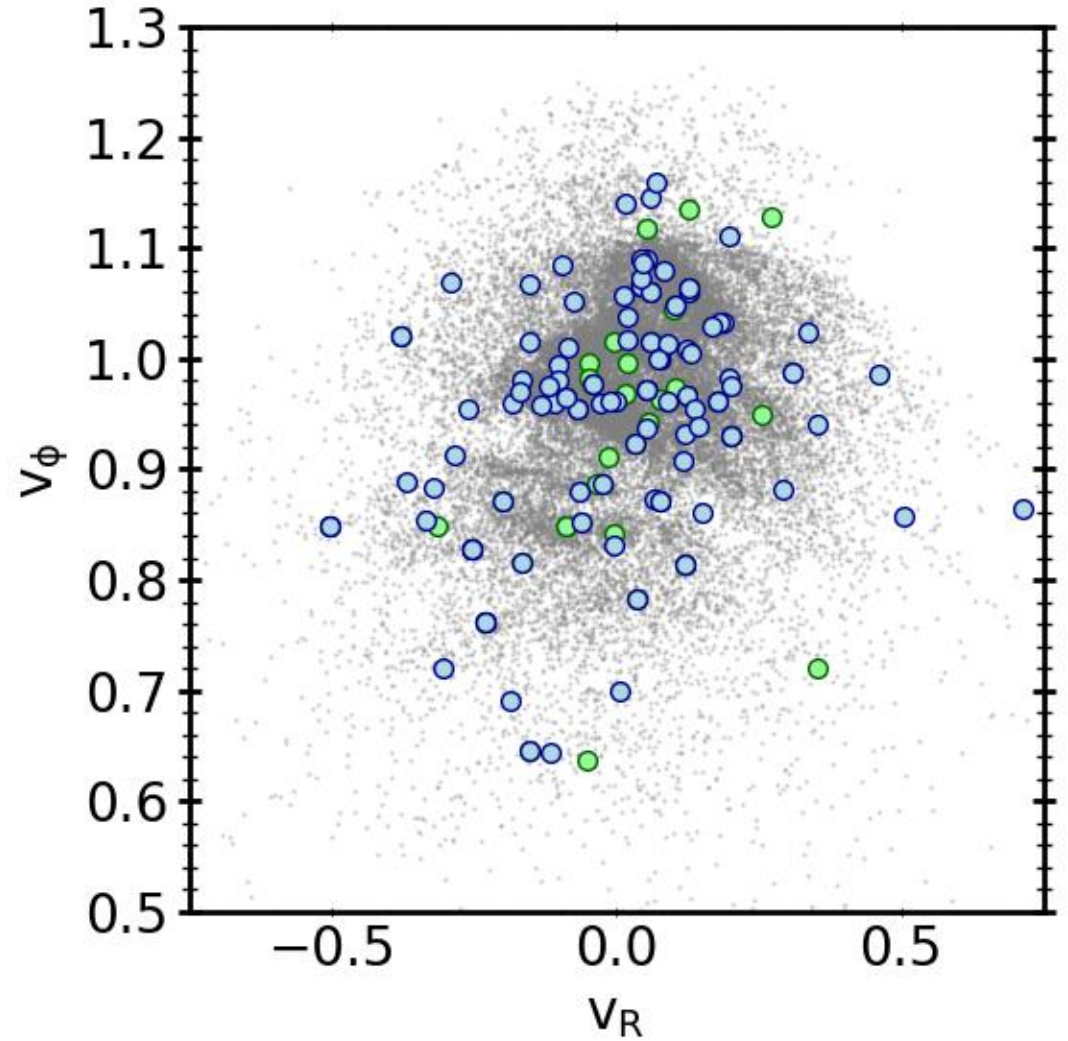

Weeks+ in Prep.

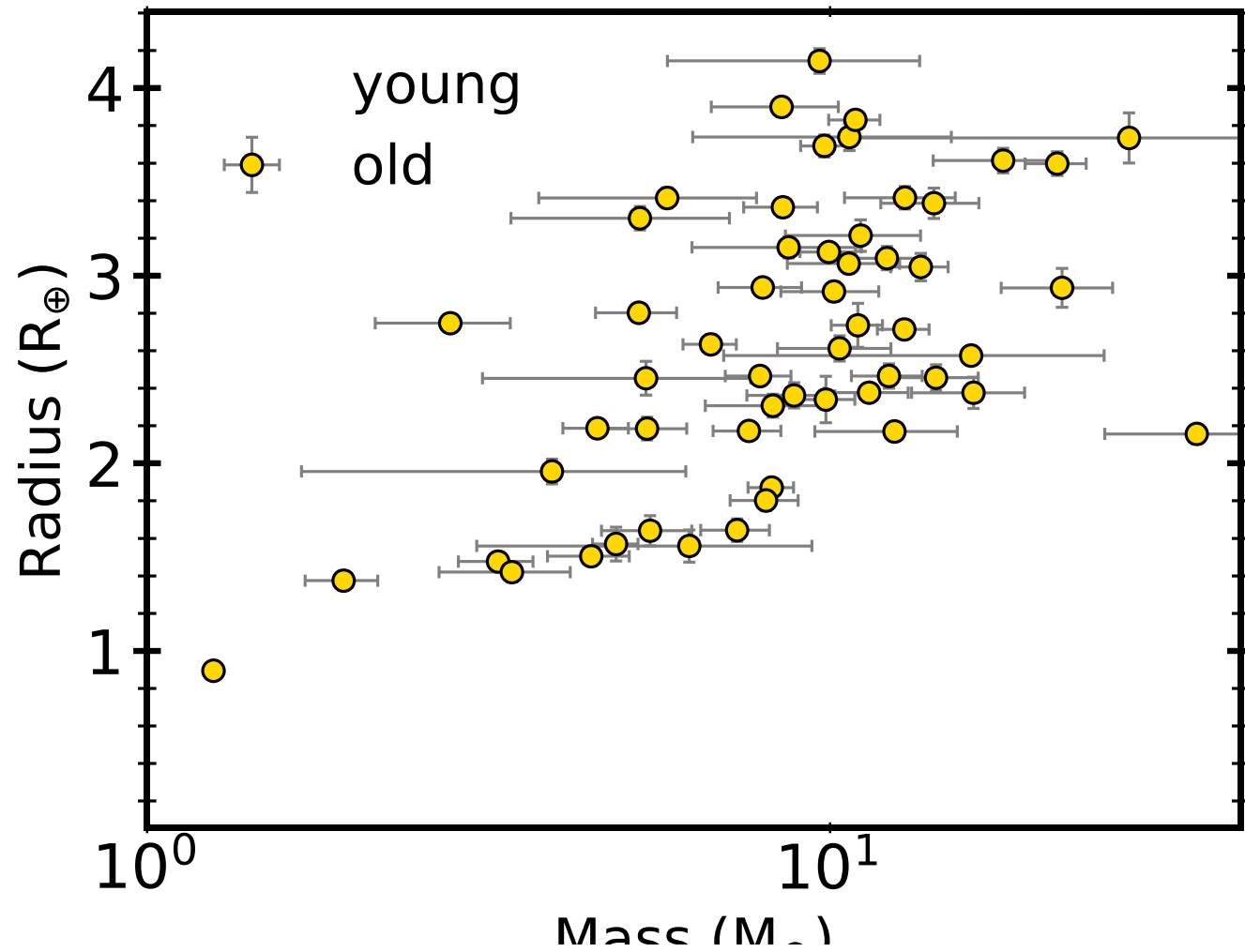

The Galactic Context

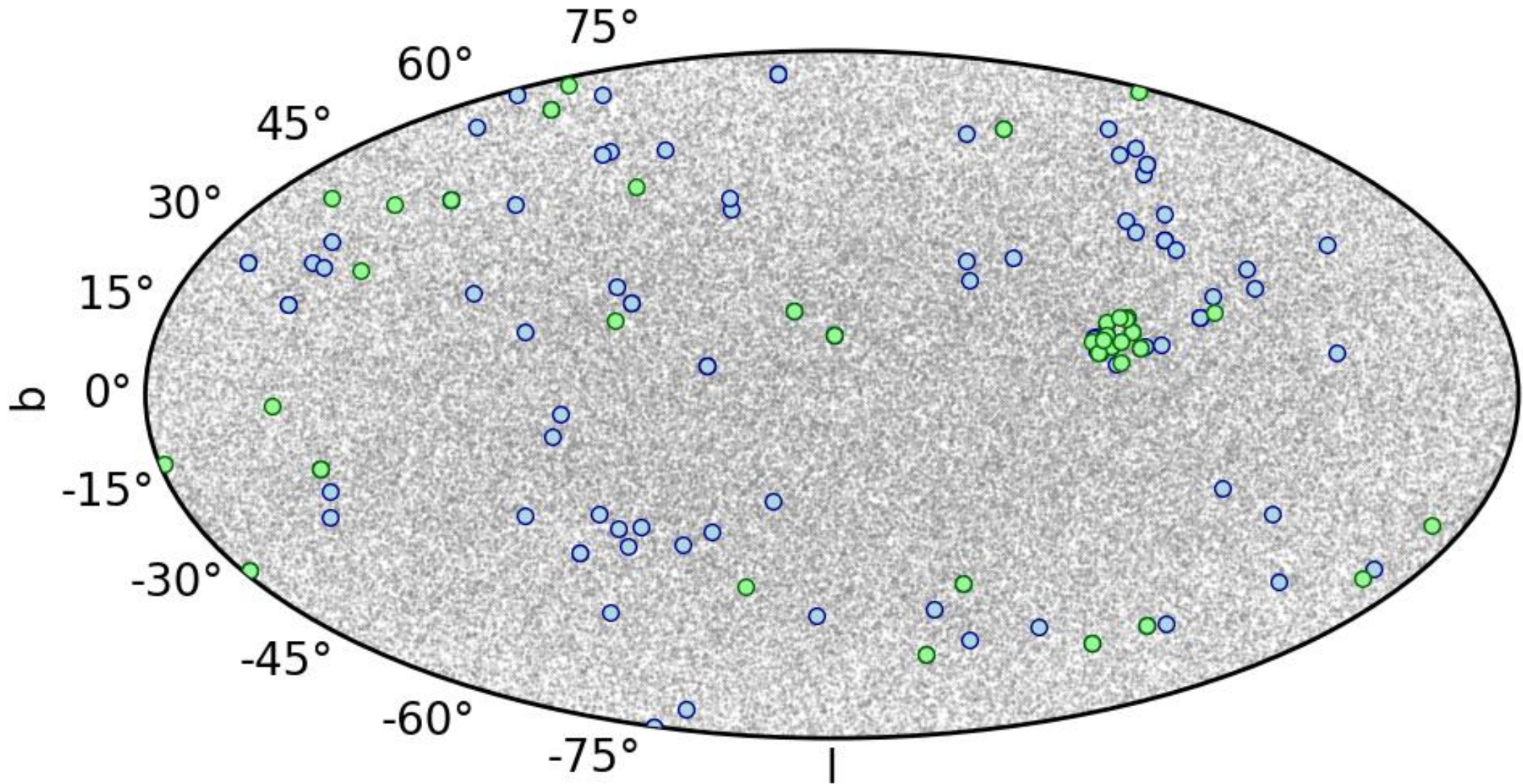

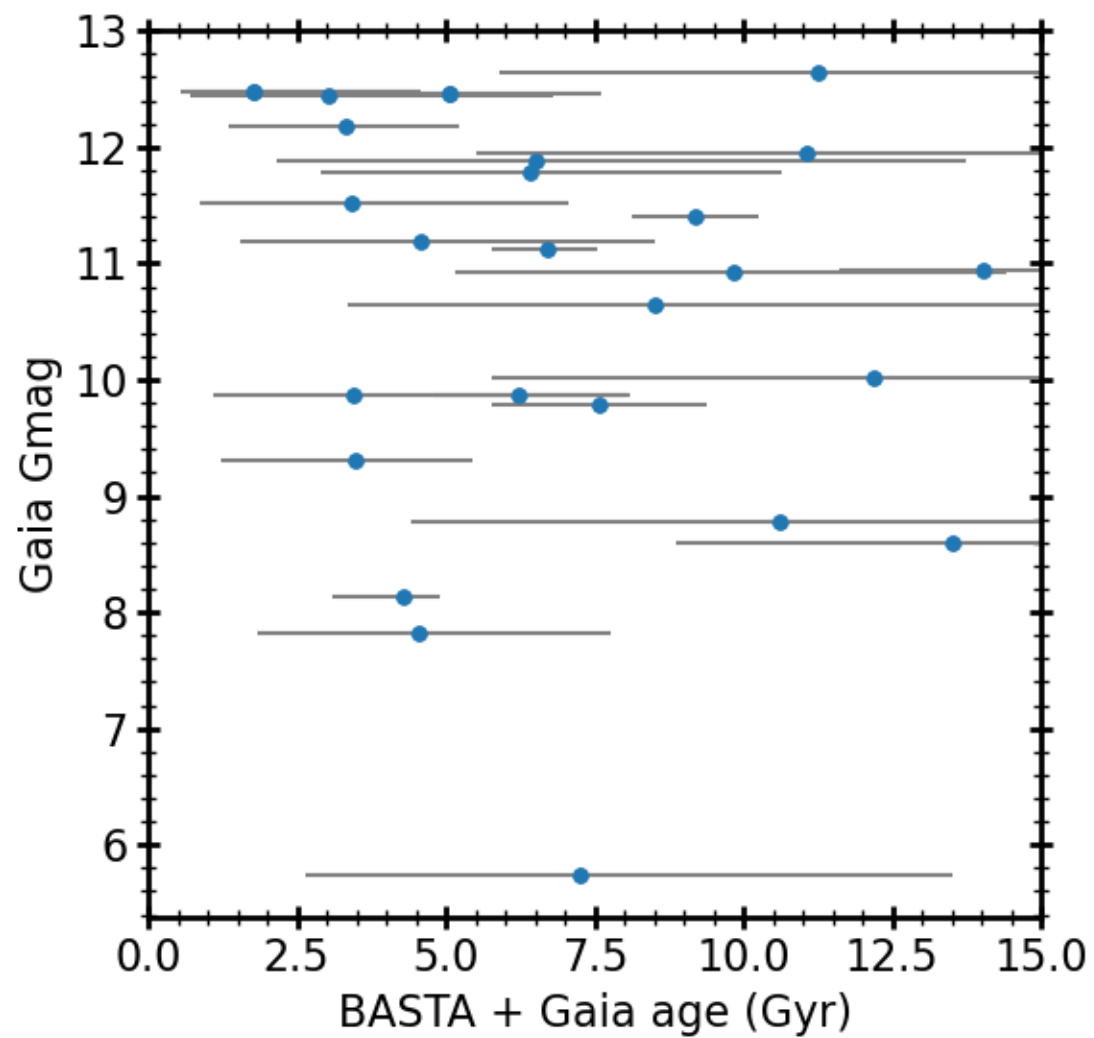
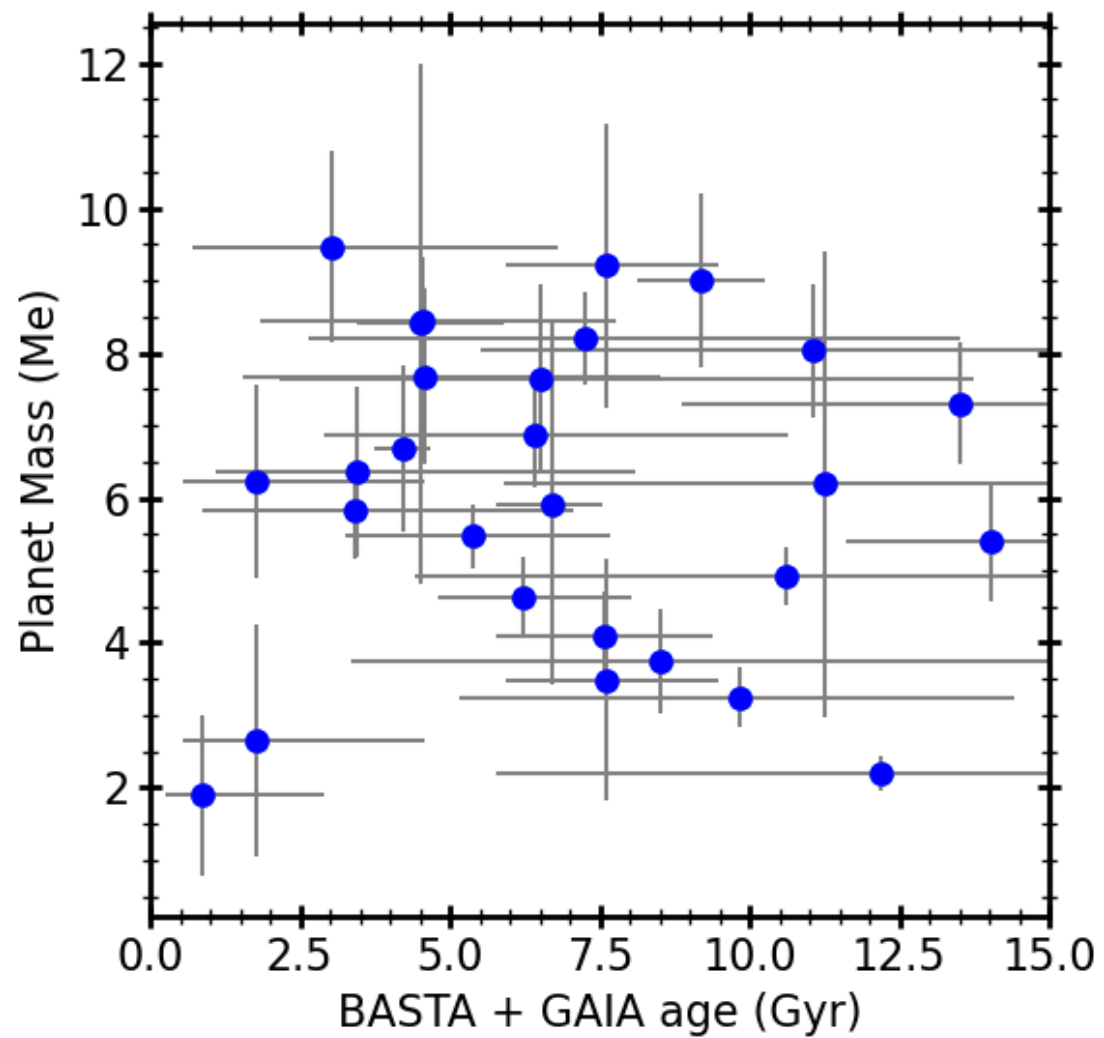

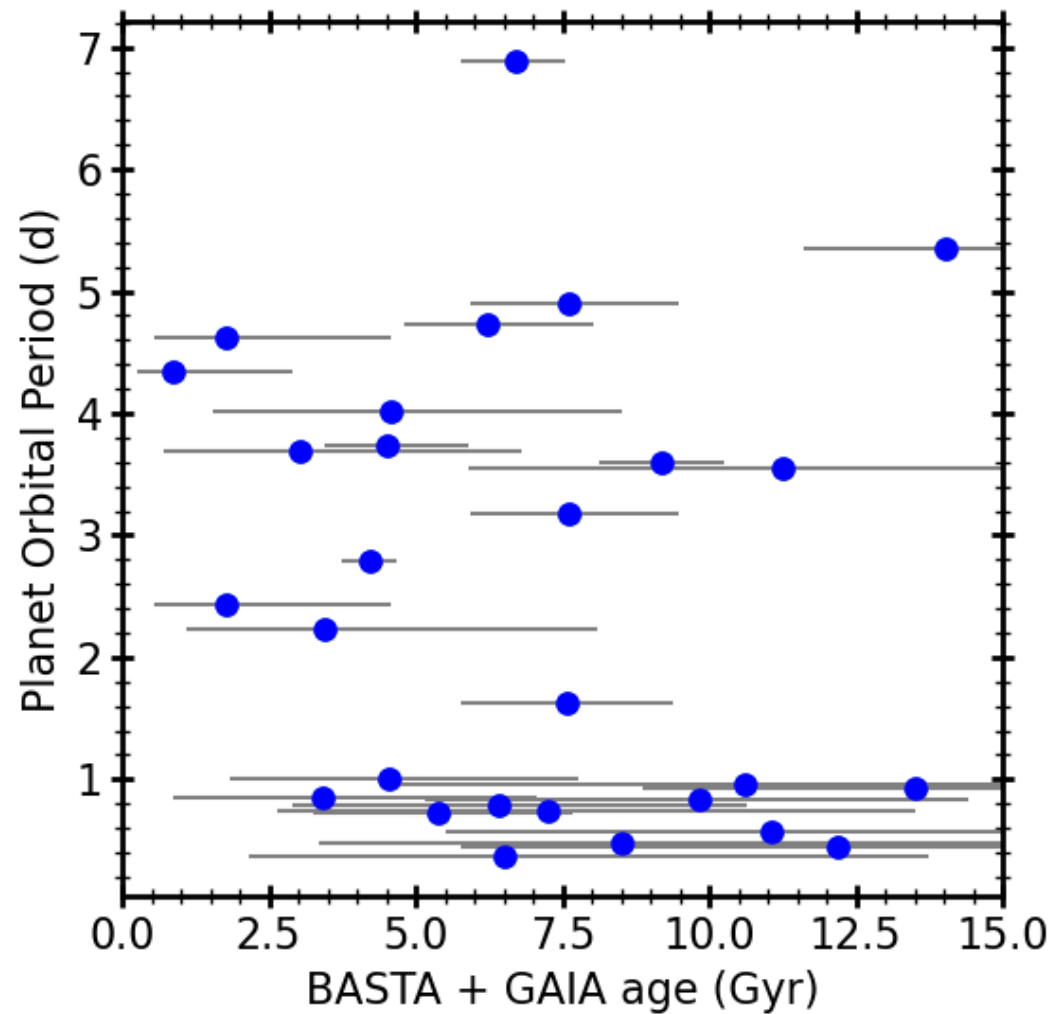
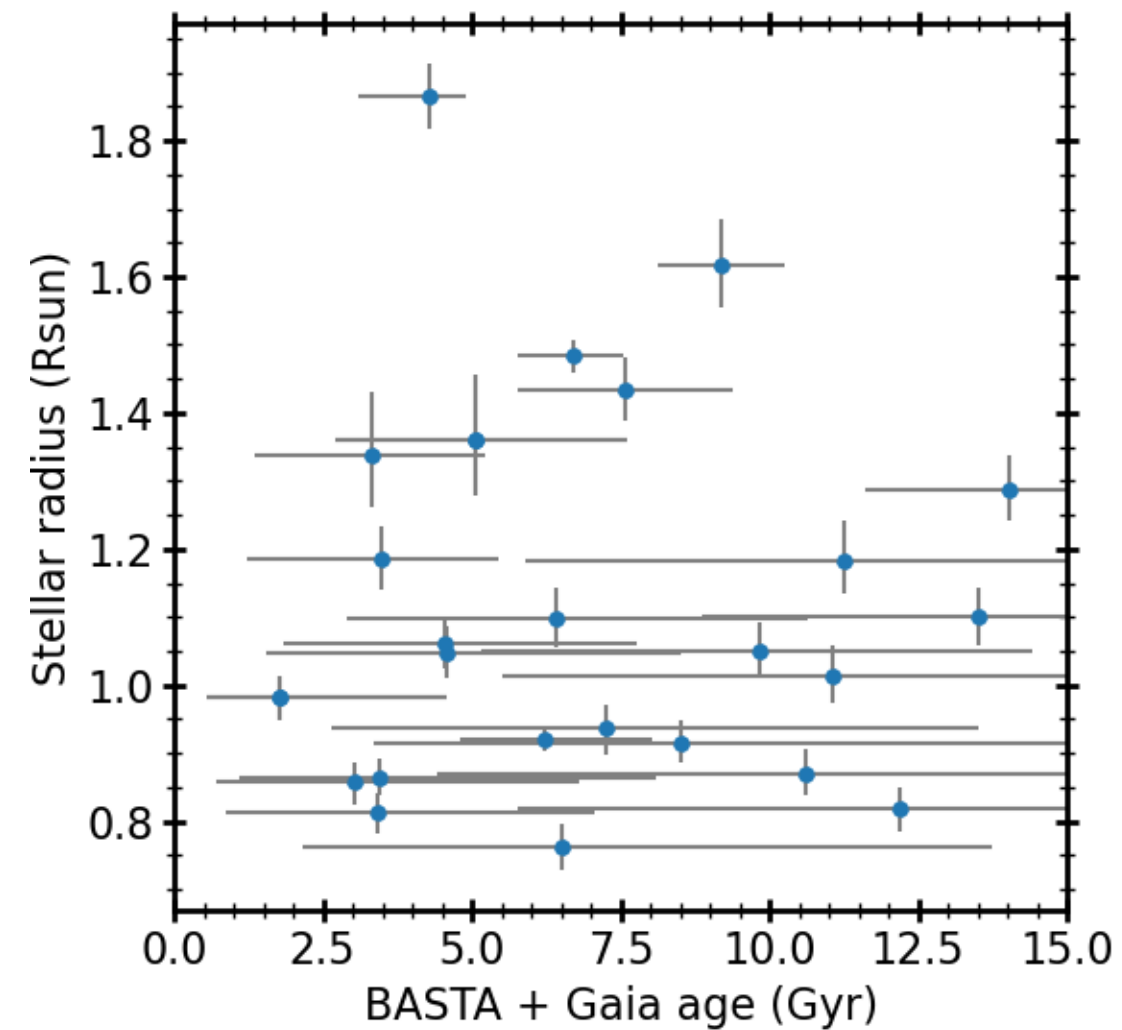

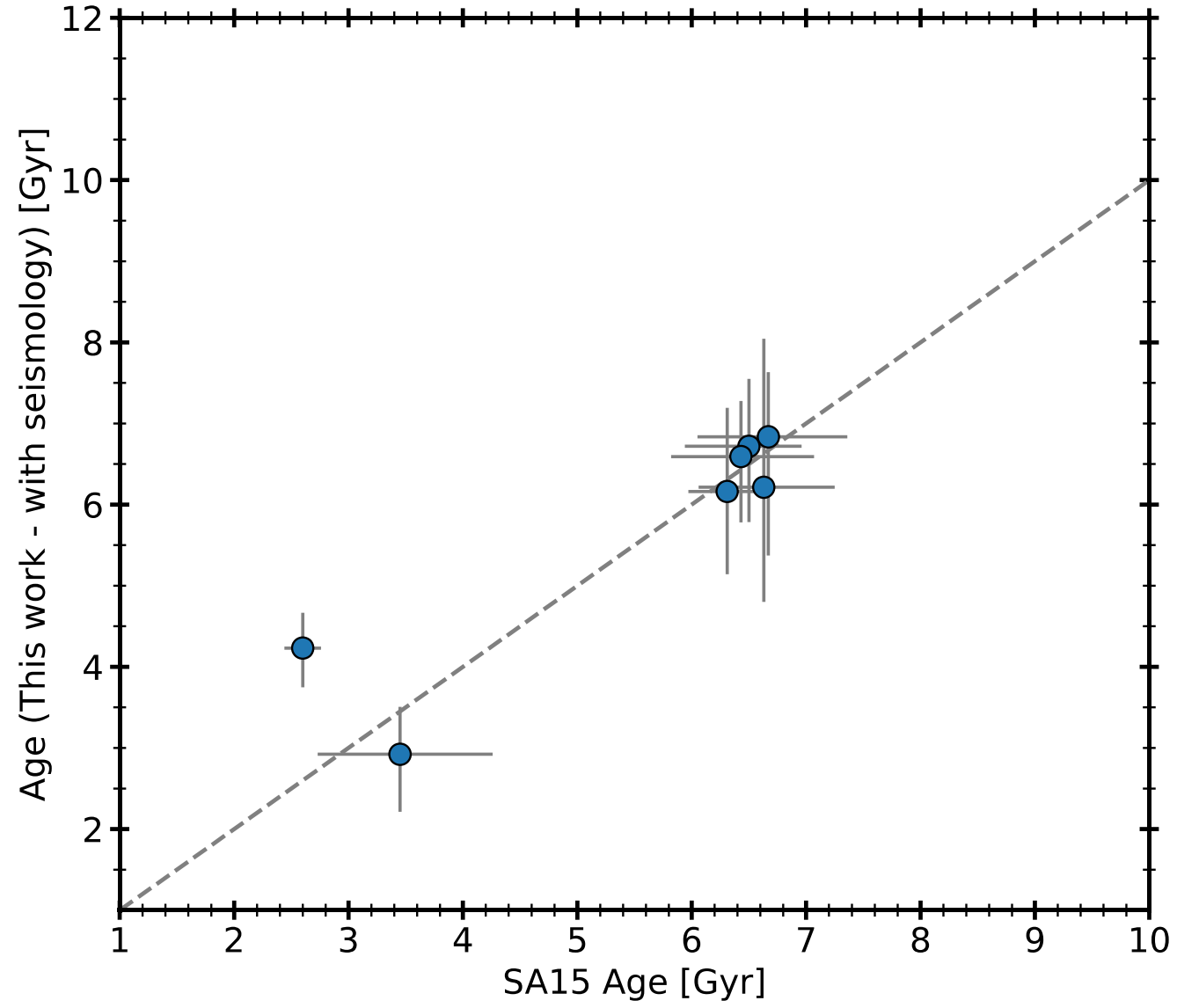

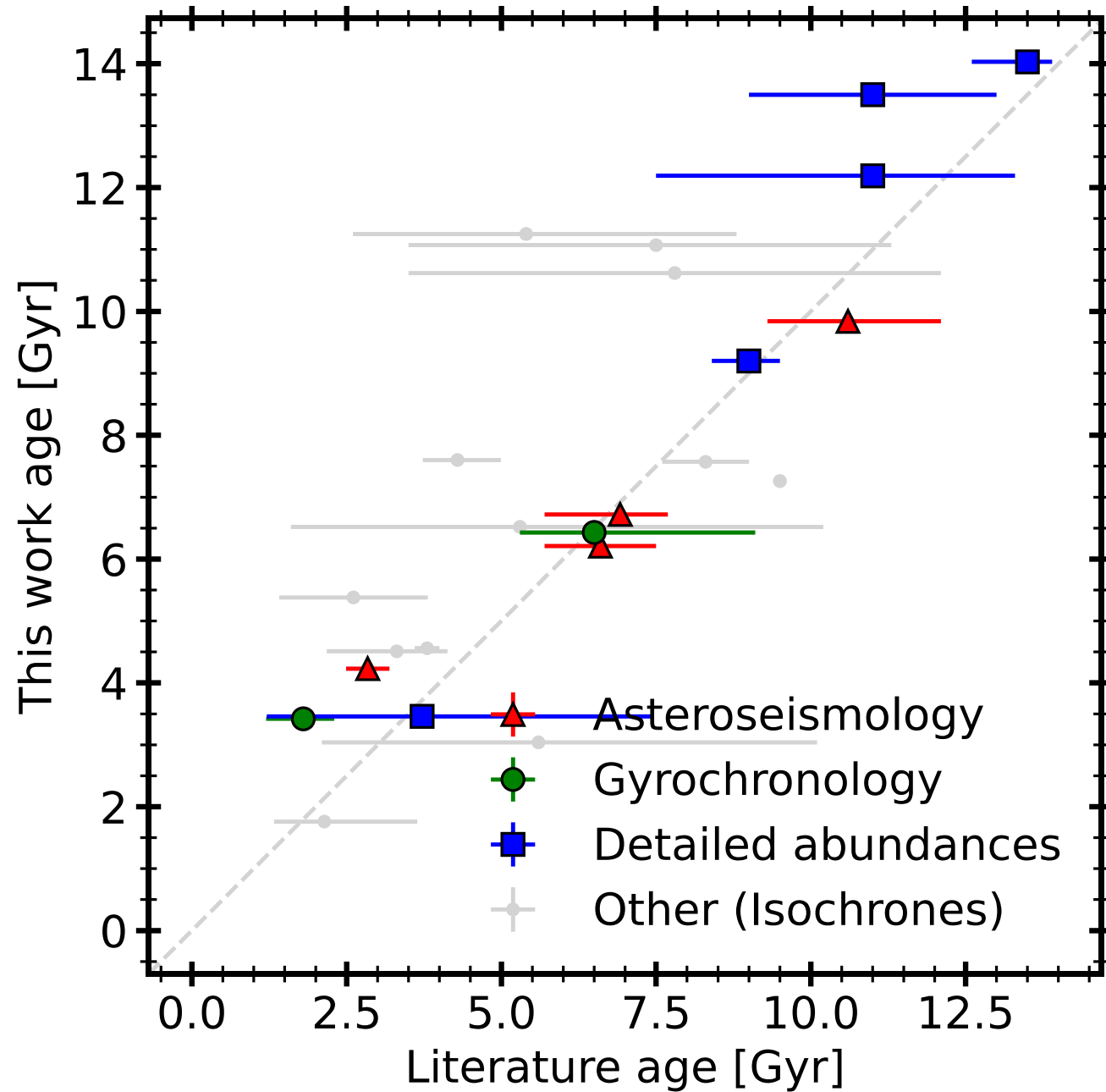

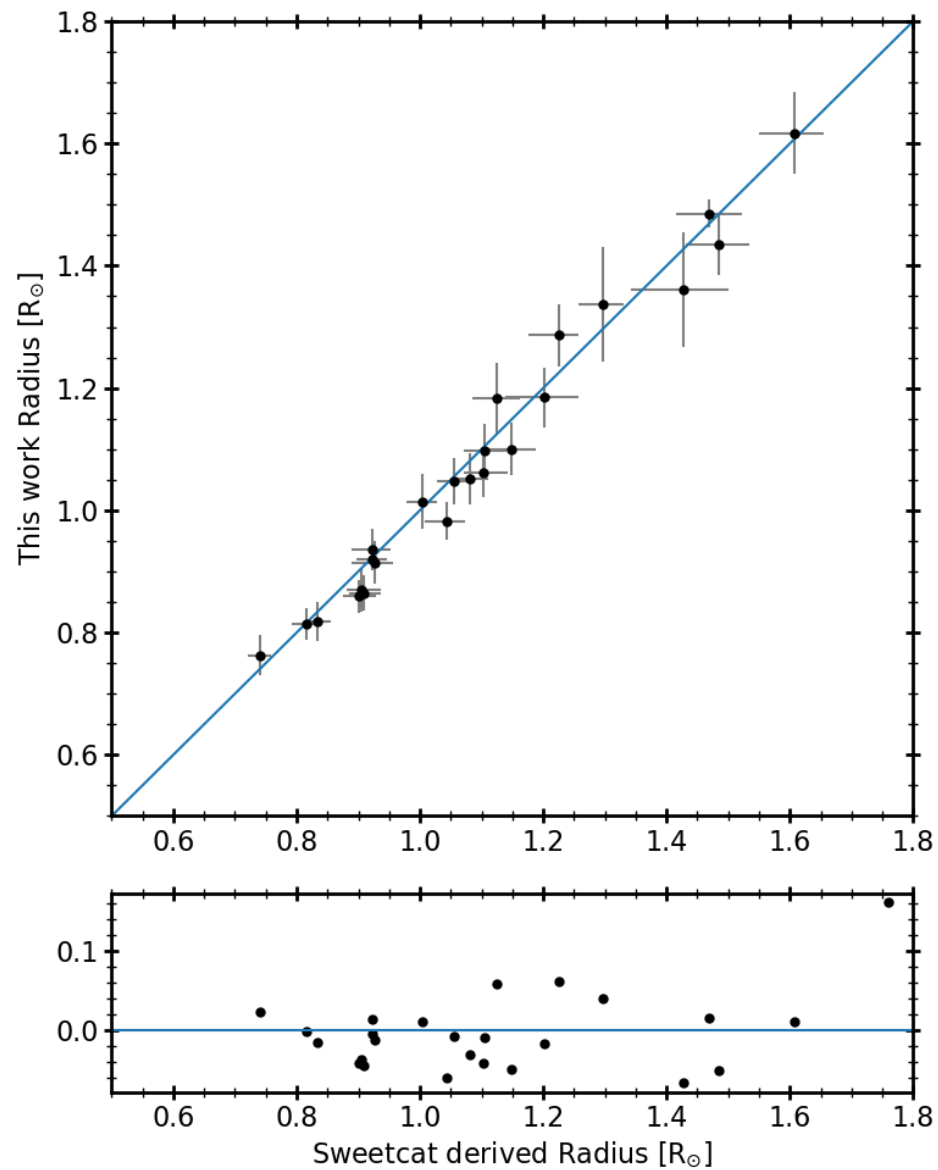
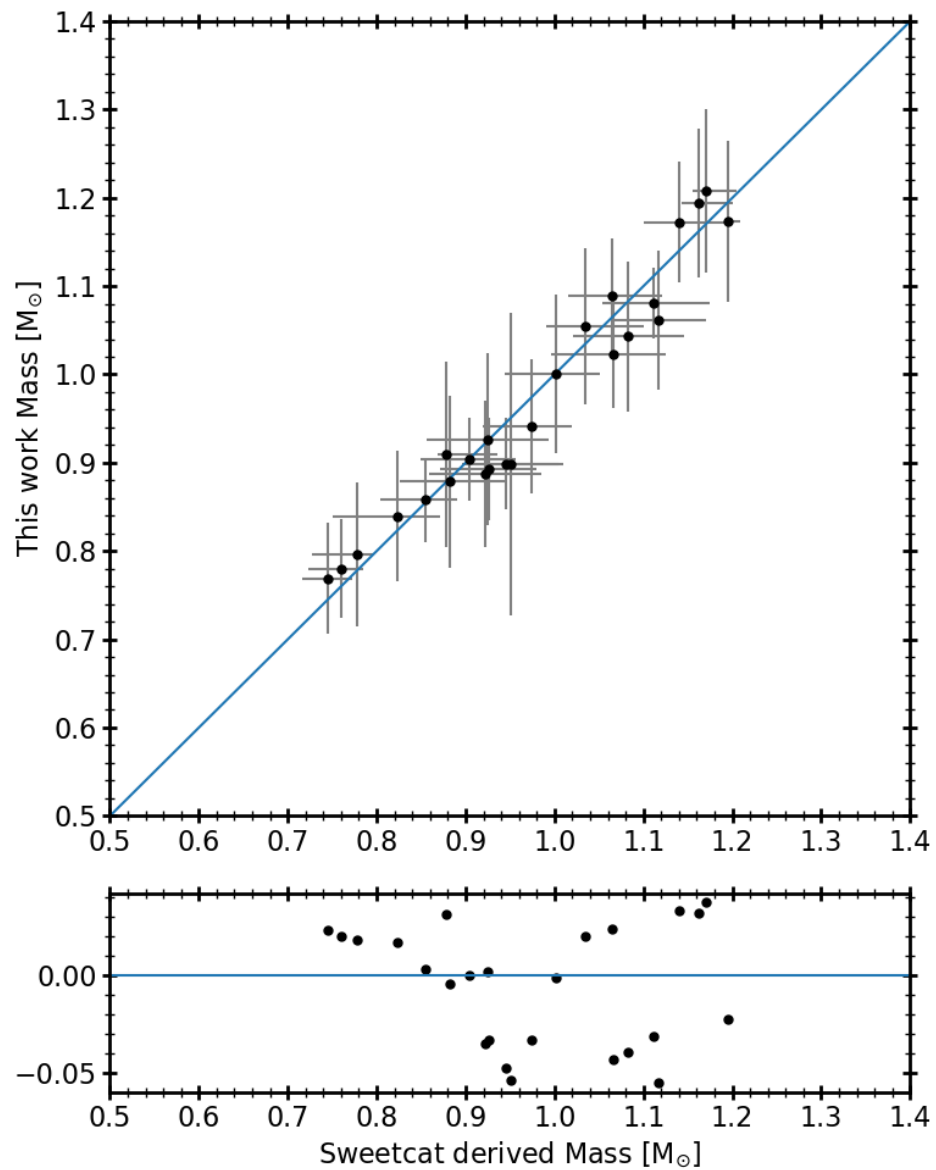

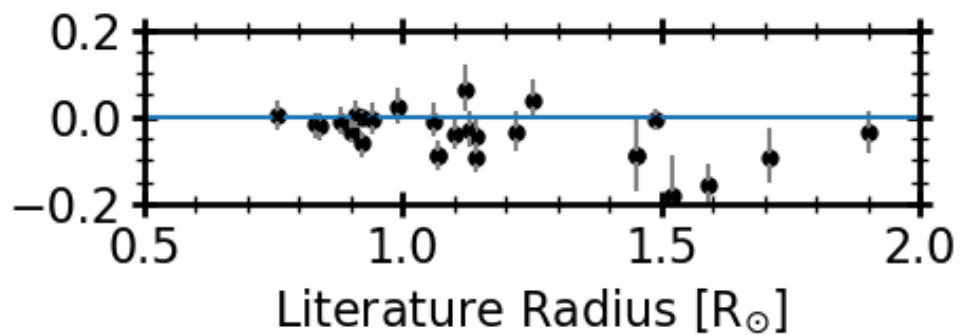
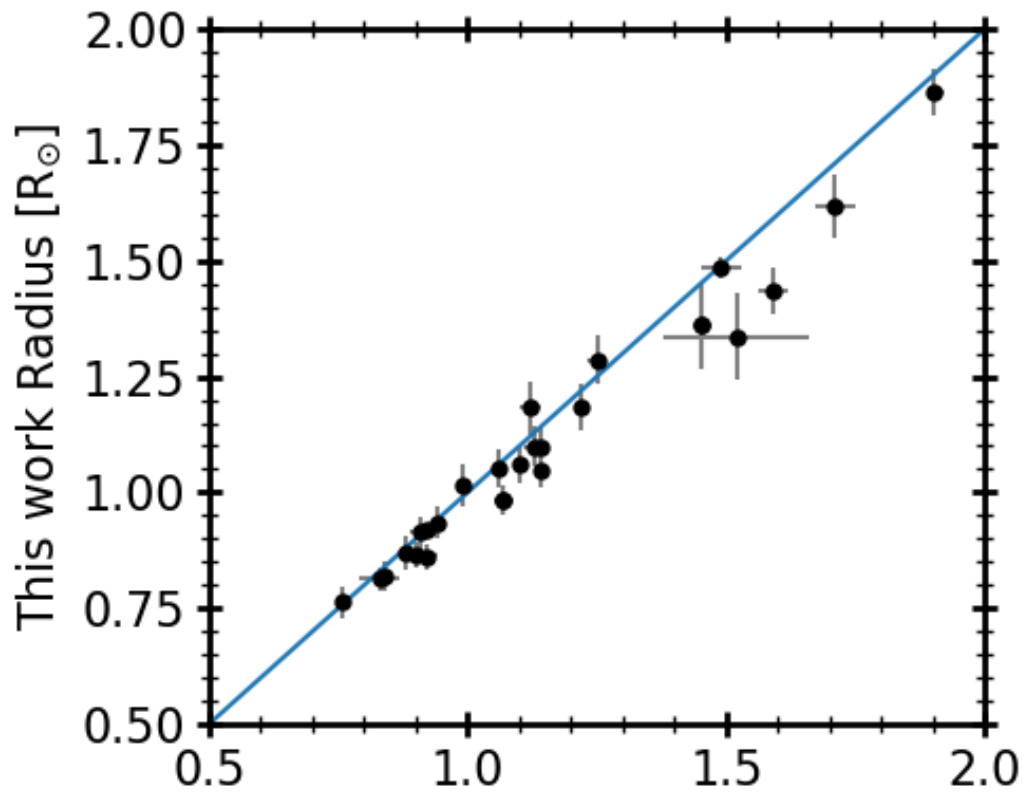
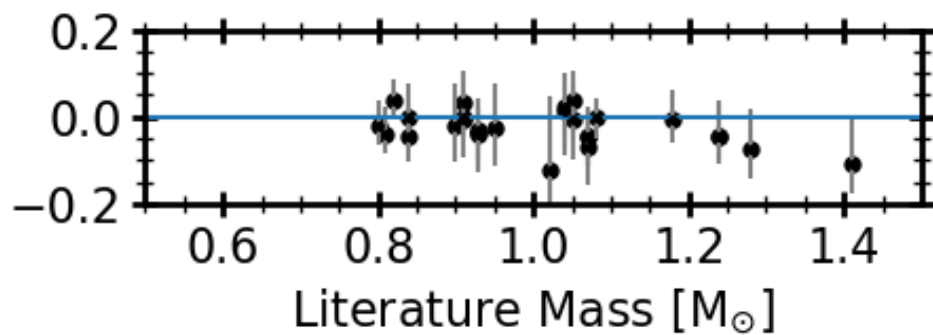
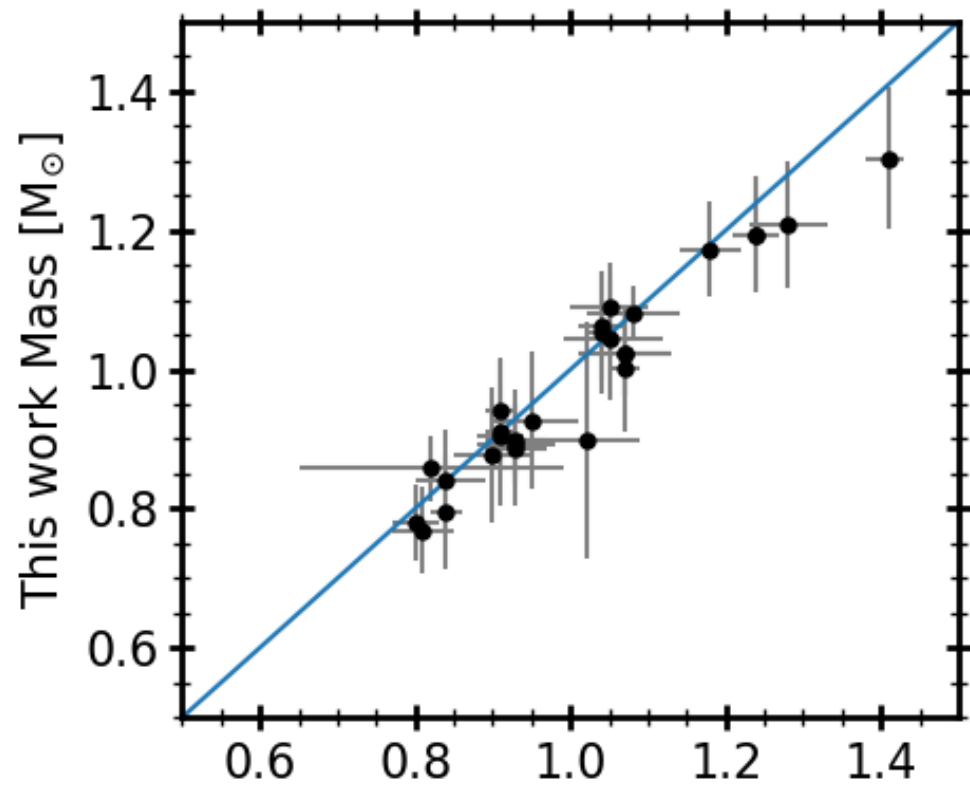

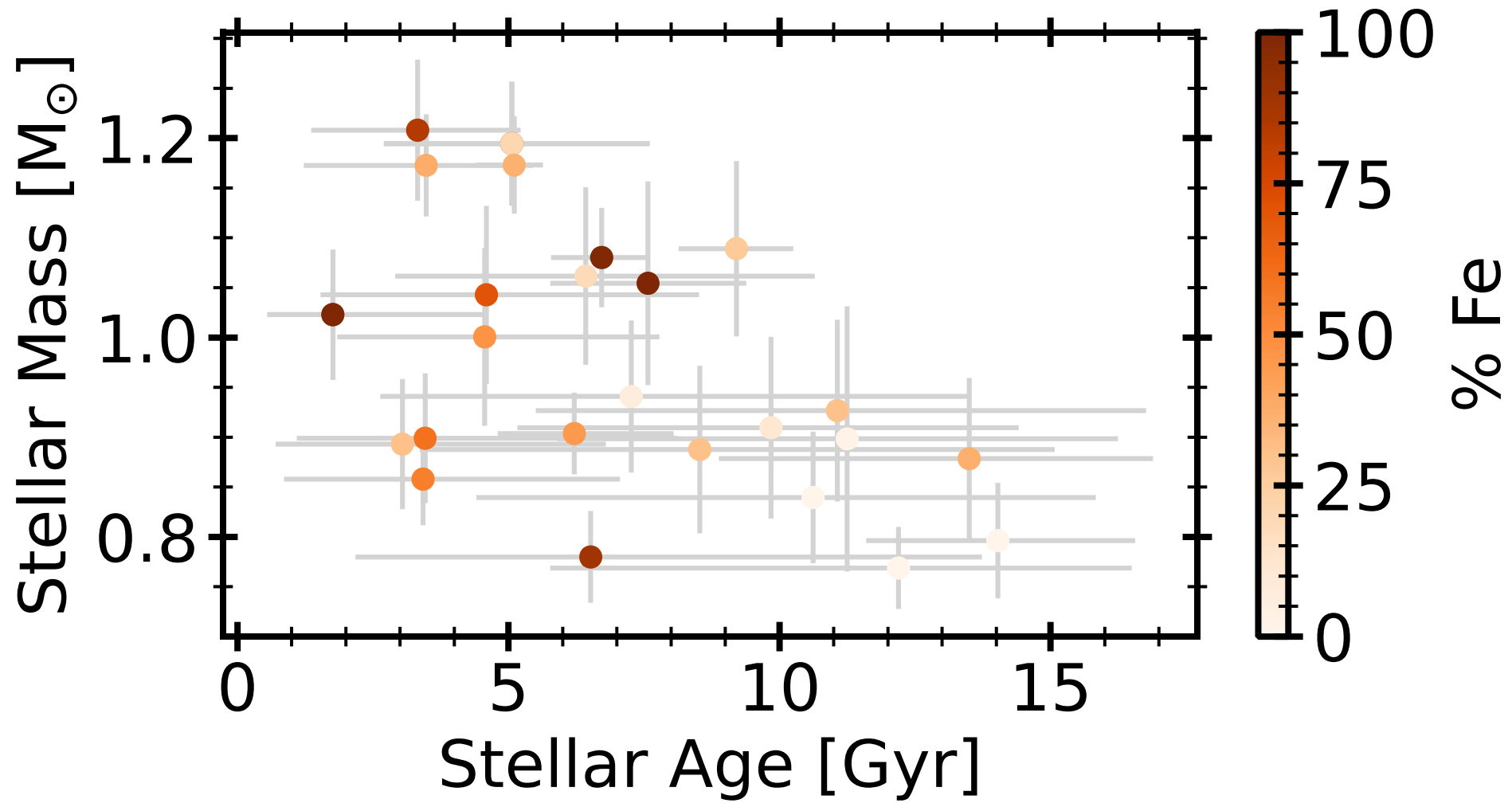

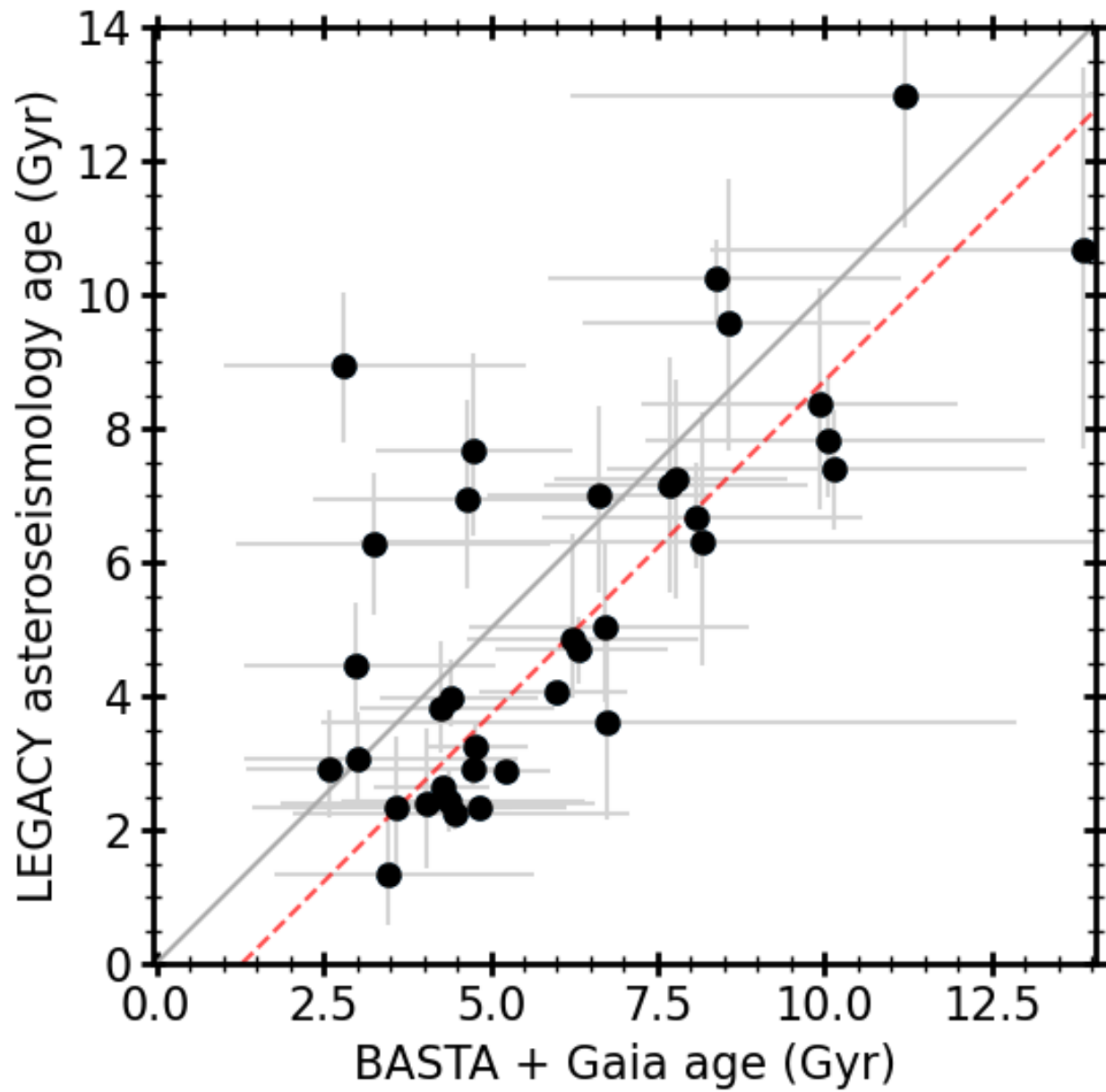

Asteroseismology &
Stellar Astrophysics



Galactic
Archaeology

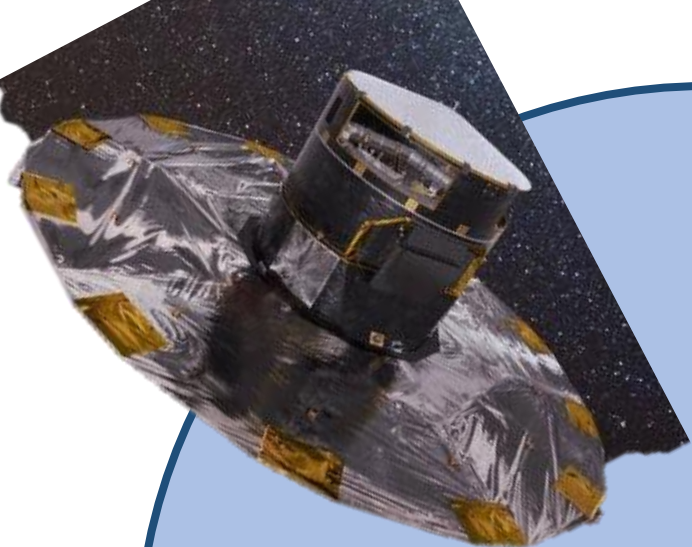

Exoplanet Science

